



Operator manual

(Original instructions)

Manual del operario

(Traducción de las instrucciones originales)

Manuel de l'opérateur

(Traduction des instructions originales)

en (English)

es (Español)

fr (Français)



TABLE OF CONTENTS

TABLE OF CONTENTS

1 FOREWORD	en-4		
2 SAFE USE	en-5		
3 MAIN COMPONENTS	en-6		
4 OPERATING CONTROLS	en-7		
5 HOW TO READ THE NAMEPLATE	en-8		
6 WARNING LABELS	en-9		
6.1 Recycling/discarding.....	en-11		
7 SAS FUNCTION	en-12		
7.1 Precautions on SAS.....	en-12		
7.2 Description of SAS features.....	en-12		
8 OPS FUNCTION	en-15		
8.1 Precautions on OPS.....	en-15		
8.2 Description of OPS features.....	en-15		
9 MAIN FUNCTIONS	en-17		
9.1 Travel control function.....	en-17		
9.2 Engine auto stop function.....	en-17		
9.3 Eco-mode.....	en-17		
10 SWITCHES AND LEVERS	en-18		
10.1 Ignition key switch.....	en-18		
10.2 Direction control lever.....	en-18		
10.3 Torque converter interlock function (Option).....	en-19		
10.4 Parking brake lever.....	en-19		
10.5 Lift lever.....	en-20		
10.6 Manual lowering valve.....	en-20		
10.7 Tilt lever.....	en-20		
10.8 Tilt lever knob switch.....	en-20		
10.9 Clamp release button (Option).....	en-21		
10.10 Mini lever (Option).....	en-21		
10.11 Joy stick (Option).....	en-23		
10.12 Arm rest (Mini lever or Joy stick models).....	en-24		
10.13 Integrated light and turn signal switch.....	en-25		
10.14 Key off head light off system (Option).....	en-26		
10.15 Rear working light (Option).....	en-26		
10.16 Horn button.....	en-27		
10.17 Rear assist grip with horn button (Option).....	en-27		
10.18 Tilt steering adjusting lever.....	en-27		
10.19 Telescopic steering (Option).....	en-27		
10.20 Accelerator pedal.....	en-28		
10.21 Brake pedal.....	en-28		
10.22 Inching pedal.....	en-28		
10.23 EZ pedal (Option).....	en-28		
10.24 Gear lock switch (Option).....	en-29		
11 BODY COMPONENTS	en-30		
11.1 Operator's seat.....	en-30		
11.2 Swivel seat (Option).....	en-31		
11.3 Comfort seat (Option: High overhead guard/ Premium cabin).....	en-31		
11.4 Seat belt.....	en-33		
11.5 Engine hood.....	en-33		
11.6 Lifting points.....	en-35		
11.7 Draw bar.....	en-35		
11.8 Overhead guard.....	en-35		
11.9 Load backrest extension.....	en-35		
11.10 Mast.....	en-36		
11.11 Forks.....	en-36		
11.12 Lights.....	en-37		
11.13 Cabin (Option).....	en-37		
11.14 Premium Cabin (Option).....	en-40		
12 INSTRUMENT	en-46		
12.1 Combination meter.....	en-46		
12.2 Multi-function display (Option).....	en-50		
12.3 TELEMATICS (OPTION).....	en-62		
13 LPG DEVICE (OPTION)	en-66		
13.1 Switches.....	en-66		
13.2 LPG related parts.....	en-67		
13.3 Engine hood.....	en-68		
13.4 Operating LPG-powered forklift.....	en-68		



13.5 Refueling your truck	en-69	22 RECOMMENDED LUBRICANT QUANTITY & TYPES.....	en-102
13.6 Important information about LPG	en-73	23 LUBRICATION CHART	en-103
13.7 Safety precautions on LPG-powered forklifts	en-73	24 TRUCK DIMENSIONS	en-104
14 PRE-OPERATION CHECK	en-74	24.1 Truck weight	en-106
14.1 Walkaround inspection	en-74		
14.2 Engine compartment inspection	en-75		
14.3 On board truck inspection	en-78		
14.4 While moving slowly	en-82		
15 STORAGE	en-83		
16 OPERATOR MAINTENANCE	en-84		
16.1 Changing tires	en-84		
16.2 Using booster cables	en-85		
16.3 Maintaining the battery terminals	en-86		
16.4 Fuse Replacement	en-86		
16.5 Air purging of the fuel system	en-87		
16.6 Draining the sedimenter	en-87		
16.7 Adjusting of parking brake operating force	en-88		
16.8 Radiator fin cleaning	en-88		
16.9 Cleaning pre-cleaner (Option)	en-88		
17 WEEKLY MAINTENANCE	en-89		
17.1 Air cleaner cleaning	en-89		
17.2 Fan and engine ancillary drive belt inspection	en-90		
17.3 Battery electrolyte check	en-90		
17.4 Torque converter oil inspection	en-91		
17.5 Retightening of nuts and bolts	en-91		
17.6 Greasing chains, mast and steering linkage	en-91		
17.7 Removing Tar from the Regulator (LPG and Gasoline-LPG models)	en-92		
18 FRAME SERIAL NUMBER	en-93		
19 PROTECT YOUR INVESTMENT WITH TOYOTA GENUINE PARTS.....	en-94		
20 PERIODIC MAINTENANCE AND REPLACEMENT	en-95		
20.1 Periodic replacement of parts and lubricants	en-95		
20.2 Periodic maintenance table	en-96		
21 SERVICE DATA	en-100		



1 FOREWORD

1 FOREWORD

Models Covered by this Manual

Internal Combustion Counterbalanced Forklift Trucks

Capacity (Load Center 500mm) kg	Engine	Model
4000	1FS	8FG35N
	1KD	40-8FD35N
4500	1FS	8FG40N
	1KD	40-8FD40N
4990	1FS	8FG45N
	1KD	40-8FD45N
5000 ^{**}	1FS	8FG50N
	1KD	40-8FD50N
6000 ^{**}	1FS	8FG60N
	1KD	40-8FD60N
7000 ^{**}	1FS	8FG70N
	1KD	40-8FD70N
8000 ^{**}	1FS	8FG80N
	1KD	40-8FD80N

^{**}Load Center 600mm

This manual contains information essential for proper operation and maintenance, as well as daily lubrication and periodic inspection procedure for your Toyota forklift truck.

Please read this manual thoroughly, even though you may already be familiar with our forklift trucks, because it contains information which is exclusive to this series of trucks. This manual is based on a standard truck model. If you have questions about other model(s), please contact the Toyota forklift dealer (Toyota dealer).

In addition to this manual, please be sure to read the separate publication entitled "Manual for Safe Operation." It contains important information about the safe operation of forklift trucks.

Toyota is constantly developing our products. We therefore reserve the right to make modifications at anytime without prior notice.

Illustrations may differ from actual design.

TOYOTA Material Handling Company

A Division of TOYOTA INDUSTRIES CORPORATION

TOYOTA INDUSTRIES CORPORATION

2-1, Toyoda-cho, Kariya-shi, Aichi 448-8671 Japan



2 SAFE USE

Before Starting Operation

- **Please read this manual thoroughly.** This will give you a complete understanding of Toyota forklift trucks and enable you to operate them correctly and safely. Proper handling of a new truck promotes performance and extends service life. Operate with special caution while becoming familiar with a new truck. In addition to the standard operating procedures, pay attention to the following safety items.
- **Please acquire a thorough knowledge of the Toyota forklift truck.** Read the operator's manual thoroughly prior to operating the truck. Get to know its operation and components. Learn about the safety devices and accessory equipment and their limits and precautions. Be sure to read the warning labels attached to the truck.
- **Please familiarize yourself with safe operating points and safe maintenance operation.** Understand and maintain work area traffic rules. Ask the work area supervisor about any special working precautions.
- **Wear appropriate clothing for operation.** Improper clothing for truck operation may interfere with smooth operation and cause an accident. Always wear appropriate clothing for easier operation.
- **Please keep away from live electric power lines.** Know the locations of inside and outside power lines and maintain sufficient distance.
- **Be sure to perform pre-operation checks and planned maintenance.** This will prevent sudden malfunctions, improve work efficiency, save money and insure a safe working operation.
- **Always warm up the engine before starting operation.**
- **Be sure to avoid forward tilt when the forks are elevated with a load.** In the worst case, this may cause overturning due to loss of stability resulting from forward movement of the center of gravity.
- **Never attempt traveling and turning with a load on the forks when they are elevated.** If travelling and turning when the forks are elevated, this may impact stability and may cause the fork lift to tip-over. When travelling, maintain a fork height above the ground of 10-20cm (6-8 inches).
- **Please avoid overloading or uneven loading.** Overloading or an uneven load is dangerous. If the centre of gravity is not evenly distributed, the heaviest side of the load should be against the fork carriage/load backrest even if the load is less than that specified on the nameplate. Also, the load should have the heaviest weight closest to the forks with lighter items on the top.
- **If you hear any unusual noise or sense anything unusual, stop, inspect and repair immediately.**
- **If the engine stops during traveling, this will affect the operation.** Stop the truck in a safe place and apply the parking brake. Steering operation becomes heavy because the power steering becomes ineffective. Operate the steering wheel more firmly than usual.
- **Please use only the recommended types of fuel and lubricants.** Low-grade fuel and lubricants will shorten service life.
- **Flammable and/or combustible materials can be damaged and in some cases ignited by a hot exhaust system or hot exhaust gases. To minimize the possibility for such damage or fire, the operator must obey the following recommended practices:**

- Do not operate the forklifts over or near flammable and/or combustible materials, including dried grass and paper scraps, etc.
- Park the forklift with rear end at least 30 cm (12 in) away from lumber (timber), veneer board, paper products and other similar materials to avoid discoloration, deformation or combustion of those materials.

Safety Requirements

- Trucks equipped with a load bearing clamp (e.g. paper clamp) shall feature control(s) with a secondary action to prevent unintentional release of the load. When any "load bearing clamp" is used on a lift truck, the control (hydraulic hand lever for example) must be configured to conform to the ISO3691-1.

Clamp release interlock is set as an option. For details, refer to Clamp release button (Option) section of this manual.



3 MAIN COMPONENTS

3 MAIN COMPONENTS

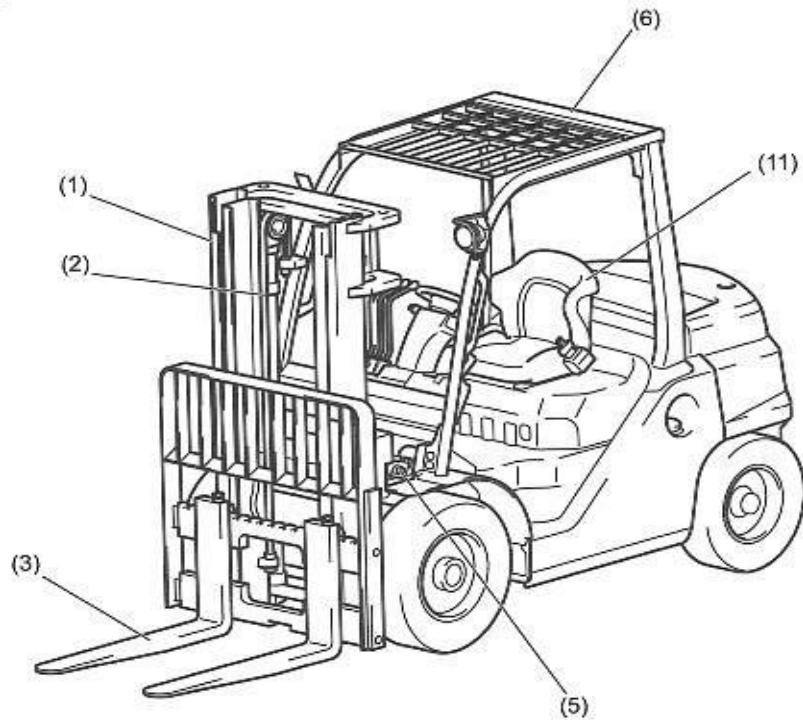

- (1) Mast
- (2) Chain
- (3) Forks
- (4) Lift cylinder
- (5) Tilt cylinder
- (6) Overhead guard
- (7) Frame

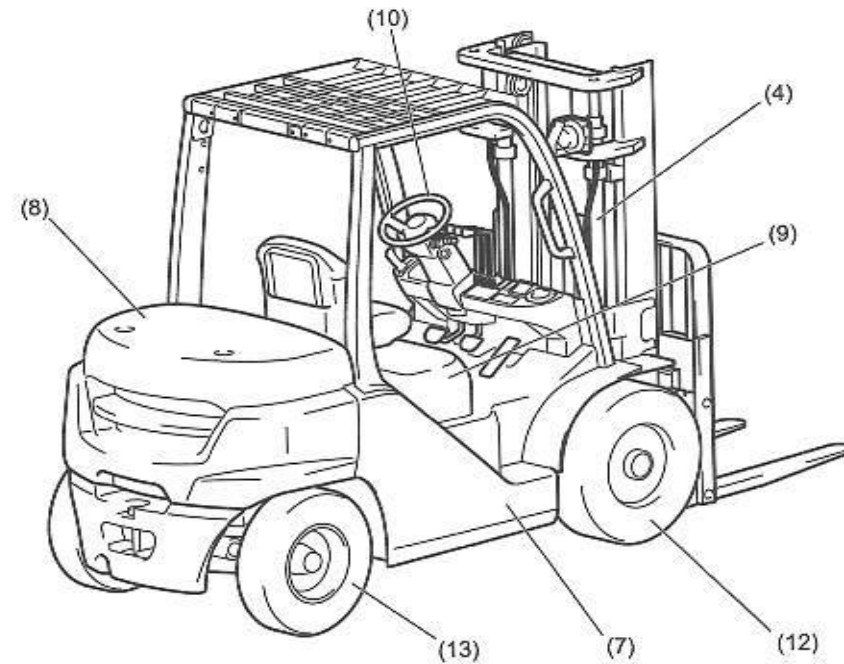

- (8) Counterweight
- (9) Engine hood
- (10) Steering wheel
- (11) Operator's seat
- (12) Drive axle
- (13) Steer axle



4 OPERATING CONTROLS

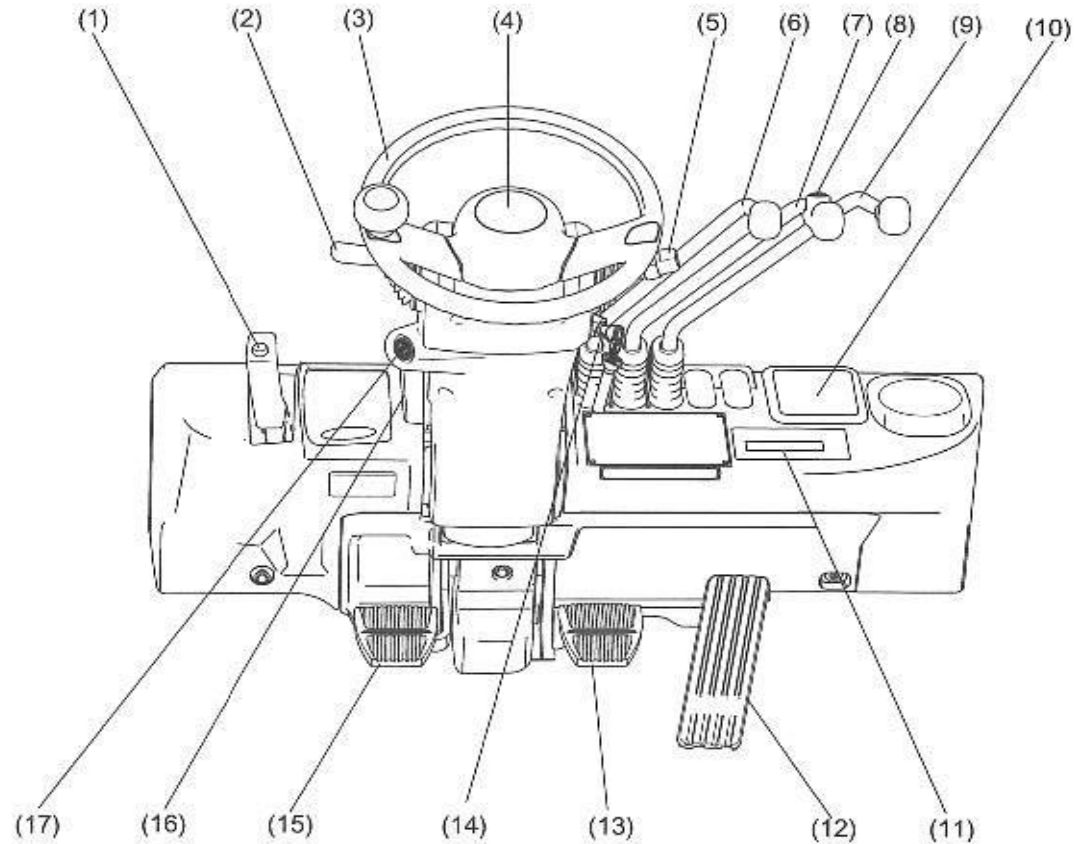

- (1) Parking brake lever
- (2) Direction control lever
- (3) Steering wheel
- (4) Horn button
- (5) Light control and turn signal switch
- (6) Lift lever

- (7) Tilt lever
- (8) Tilt lever knob switch
- (9) Attachment lever (Option)
- (10) Multi-function display (Option)
- (11) Combination meter
- (12) Accelerator pedal

- (13) Brake pedal
- (14) Ignition key switch
- (15) Inching pedal
- (16) Tilt steering adjusting lever
- (17) Gear lock switch (Option)





5 HOW TO READ THE NAMEPLATE

5 HOW TO READ THE NAMEPLATE

The load capacity is engraved on the nameplate.

Make sure of the load center and capacity before starting the operation.

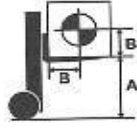
(The sample shows that of an English version.)

TOYOTA FORKLIFT TRUCK			
MODEL	(1)	FRONT TREAD	(6)
CODE NO. OF SPECIAL MODEL, MODEL OF ATTACHMENT	(2)	TIRE SIZE FR	(7)
FRAME NO.	(3)	TIRE PRESS. FR	(8)
TRUCK WEIGHT	(4)	TIRE SIZE RR	(7)
MAX. LIFTING HEIGHT 'A'	(5)	TIRE PRESS. RR	(8)
		PRCD. YEAR	(9)
		NOMINAL POWER	(13)
		RATED CAPACITY	(10)
 CE			
ACTUAL CAPACITY WITH VERTICAL UPRIGHT EQUIPPED AS SHOWN.			
ACTUAL CAPACITY	(11)	(11)	(11)
LOAD CENTER 'B'	(12)	(12)	(12)
 TOYOTA		<small>TOYOTA INDUSTRIES CORPORATION 2-1, Toyoko-cho, Kariya-shi, Aichi 448-8671, Japan</small>	

- (1) Truck model
- (2) Code No. of special model, model of attachment
- (3) Frame No. - special number for the truck
- (4) Truck weight
- (5) Maximum lifting height
- (6) Front tread
- (7) Tire size
- (8) Tire pressure
- (9) Year of production
- (10) Rated capacity
- (11) Load capacity
- (12) Load center
- (13) Nominal power



6 WARNING LABELS

Warning labels are attached on a truck. Please be sure to read them thoroughly. (The sample shows those of an English version.)

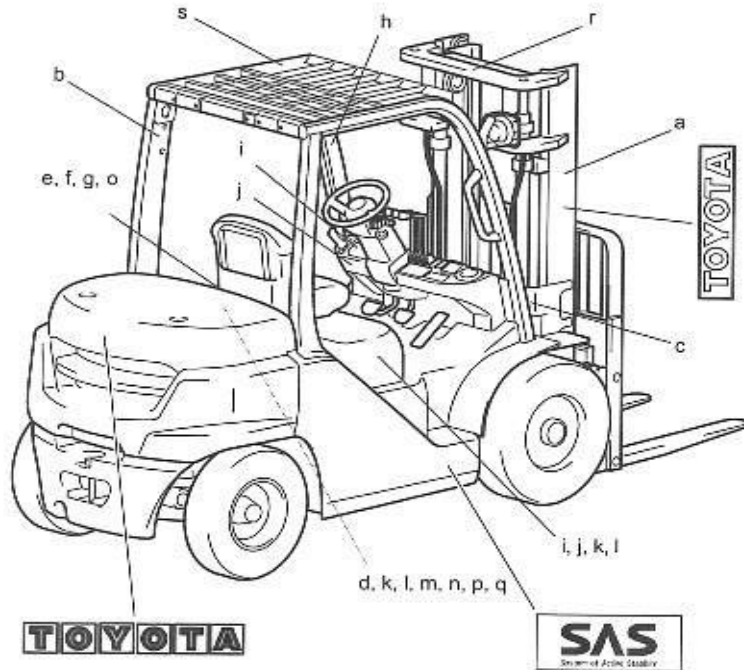

a



Never lift people with your truck or allow anyone under the forks or load. Safety of people around you is your responsibility.

b

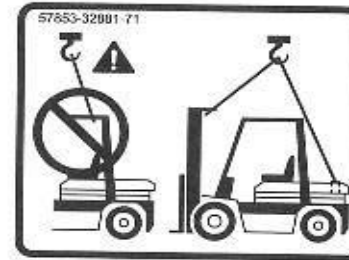

When lifting the truck don't risk dropping the truck, never use the overhead guard to pick it up. Use the counterweight to lift the truck.

c



Refer to the warning label for the sound power level of the truck. (This label is a sample. The value on the label varies depending on the model.)

d



Diesel engine models
Do not touch the exhaust pipe when it is hot.

e



⚠ WARNING
Please read this Operator's Manual carefully before use.

f

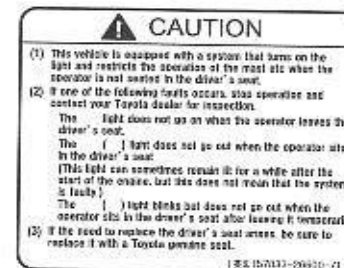

This truck is equipped with OPS (Operator Presence Sensing). Be sure to read and follow the instruction of the warning label.



6 WARNING LABELS

g 3.5 - 4.5 ton models/ Models with optional Cabin

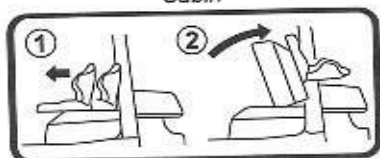

Models with Mini lever/Joy stick (Option)

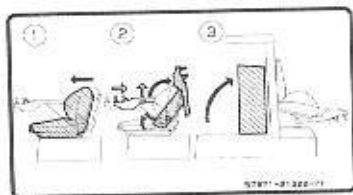

Models with Cabin (Option) + Mini lever/ Joy stick (Option)



Models with +75 mm overhead guard(Option) + Mini lever/ Joy stick (Option)

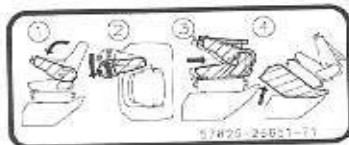

Don't damage your truck, follow the instructions on the warning label when opening the engine hood.

Tip over can cause serious injury or death. Lookout for and avoid the hazards that cause them and use the seat belt. If your truck tips, stay in the seat, lean away from the tipping direction, hang on, and brace your feet.



This truck is equipped with SAS. Be sure to read and follow the instruction in the SAS FUNCTION section of this manual.



Apply the parking brake according to the Parking brake lever section of this manual.



The fan is coloured white to make it easier to see when it is turning. You still need to watch out for this decal and stay clear.



Do not open the radiator cap when the coolant is hot.



Be sure to use only specified fuses. Refer to the FUSE REPLACEMENT section of this manual for specified fuses.



This label indicates the hydraulic oil tank inlet.



o Gasoline engine models



If you fill the fuel tank, make sure you use the proper fuel. A mistake could cause very costly repairs.

Diesel engine models



Diesel engine models
Be sure to read the instructions in this Operator's Manual before performing the maintenance of the sedimenter.

p



q



Diesel engine models
Replace the timing belt every 4000 hours of use.
Failure to do so could result in serious engine damage.
The timing belt caution function will inform the operator when the timing belt needs to be replaced. Refer to the INSTRUMENT chapter of this manual for details.

r



This decal may be placed in several places on the truck, but look for it, especially on the mast and on attachments. When you see it, stay clear.

s



Low height overhead guard (Option)
⚠ CAUTION
Low height overhead guard is equipped.
The height of overhead guard is lower than the regulation height specified by ISO 6055.
Operate this truck only when your head clearance (containing a helmet) from the underside of the overhead guard is 24 mm and over.

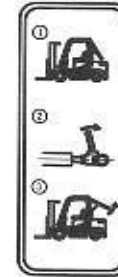

Models with optional Cabin
Rear window of the Cabin can be opened by releasing the lock lever at the bottom of the window. Refer to the CABIN (OPTION) chapter of this manual for details.



Models with optional Cabin
Do not travel the truck with Cabin with the rear window opened at maintenance mode.

6.1 Recycling/discarding



In accordance with EU Directive 2006/66/EC, this symbol indicates 'separate collection' for all batteries and accumulators.

Your truck uses a lead accumulator and, in case of some battery-powered truck, a lithium battery.

Materials contained in batteries (include accumulators) are hazardous to the environment and humans, so batteries should be returned to the manufacturers for recycling.

Discarding the battery

When the working life of the battery in the truck is at an end (exchange to a new battery) or if the entire truck is to be scrapped, special regard to environmental risks shall be taken when disposing/ recycling batteries. Consult the Toyota dealers about exchange or discarding the batteries.

7 SAS FUNCTION

7 SAS FUNCTION

7.1 Precautions on SAS

(SAS: System of Active Stability)

Whenever you use a Toyota forklift equipped with SAS, check the warning labels to determine which SAS feature(s) your truck has been equipped with. Do not operate the truck if any SAS feature is not operating properly.

The following are examples of the warning labels which will be affixed on SAS equipped trucks to identify the SAS features installed on that specific truck.

[Figure 1]



Figure 1

This label will be affixed on SINGLE TIRE trucks equipped with SAS. As pictographs on the label indicates, this truck is equipped with the following SAS features:

- Active control rear stabilizer
- Active mast function control
- Active steering control

[Figure 2]



Figure 2

This label will be affixed on DUAL TIRE trucks equipped with SAS. As pictographs on the label indicates, this truck is equipped with the following SAS feature:

- Active mast function control
- Active steering control

For those models fitted with double/dual wheels, there is no Active control rear stabilizer.

⚠ DANGER

Toyota forklifts equipped with SAS will operate and handle differently than similar forklifts without SAS. Operators must use caution when changing between trucks with and without SAS features. Operation of forklifts without SAS in the same manner as forklifts with SAS can result in loss of control and potential tip over.

⚠ CAUTION

Before operating a truck equipped with SAS, familiarize yourself with the SAS feature or features and be sure that the spanner indicator lamp is not illuminated. The span-

ner indicator lamp  will illuminate or blink in the event of a SAS malfunction and the truck should not be operated until it has been repaired.

- While operating a truck equipped with SAS, should the spanner indicator lamp illuminate or blink, or an error code be indicated on the display, park the truck in a safe location, apply the parking brake and have the truck inspected by the Toyota dealer.
- The SAS is electronically controlled. The system may need to be initialized after completion of maintenance.
- Do not remove or modify the SAS features. If inspection of the SAS is required, ask the Toyota dealer.
- When washing the truck, caution is required to prevent water from being directly applied to the electrical parts used in the SAS. These electrical parts include a controller, sensors and switches.
- Once you have fitted or replaced any attachment on a forklift, ask the Toyota dealer for an inspection and load rating if required.
- If you use two or more removable attachments alternately, the heaviest one should be used to carry out matching (SAS setting). Ask the Toyota dealer to request compatibility matching.
- When mounting forks or attachments to a truck without forks, the attachments must be compatible with the model. Ask the Toyota dealer to request compatibility matching.

7.2 Description of SAS features

Active control rear stabilizer

When the truck makes a turn on the spot, a centrifugal force will be generated in the lateral direction of the truck. In such event, this feature will temporarily lock the rear wheels to support the truck on four wheels and prevent the rear axle swing motion on the truck. Thus, the stability of the truck during right and left turns will be enhanced.

The locking of the rear axle swing motion is referred as "Swing Lock".

⚠ CAUTION

- This feature is intended to enhance the stability of the forklift under certain conditions, but cannot prevent the forklift from tipping over under all circumstances. You must continue to use caution when operating the forklift.
- Traveling with forks elevated may cause tip-over as the center of gravity shifts forward and upward. Never travel or turn when forks are elevated with or without load.



Automatic fork leveling control

Trucks with a standard lever

When moving the tilt lever forward while pressing the tilt lever knob switch, the forks will stop automatically at the horizontal position (the mast positioned vertically).

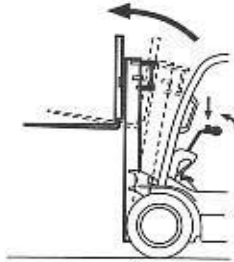

NOTICE

- When moving the tilt lever backwards, the forks will not stop at the horizontal position even if the tilt lever knob switch is pressed (except trucks equipped with Mini lever or Joy stick).
- To cancel the Automatic fork leveling control in the middle of operation, release the tilt lever knob switch.
- After stopping the forks at the horizontal position with the tilt lever knob switch pressed, you may want to tilt the forks further forward. Return the tilt lever to the neutral position once. Then, after releasing the tilt lever knob switch, move the tilt lever again.

When moving the tilt lever from the backward to forward position while pressing the tilt lever knob switch, the forks will:

	Not loaded	Loaded
High Lift Height (Over 6 feet or 2 m)	Stop at the horizontal position (with mast positioned vertically)	Not tilt forward
Low Lift Height	Stop at the horizontal position (with mast positioned vertically)	Stop at the horizontal position (with mast positioned vertically) or up to 1° backward depending on the load

Trucks with Mini lever or Joy stick (Option)

When moving the tilt lever forward while pressing the automatic fork leveling switch, the forks will stop automatically at the horizontal position (the mast positioned vertically).

When moving the tilt lever backward while pressing the automatic fork leveling switch, the forks will also stop automatically at the horizontal position (the mast positioned vertically).

NOTICE

- To cancel the Automatic fork leveling control in the middle of operation, release the automatic fork leveling switch.
- After stopping the forks at the horizontal position with the tilt lever knob switch pressed, you may want to tilt the forks further forward or backward. Return the tilt lever to the neutral position once. Then, after releasing the automatic fork leveling switch, move the tilt lever again.

When moving the tilt lever while pressing the automatic fork leveling switch, the forks will:

		Not Loaded	Loaded
Forward tilt	High Lift Height (Over 6 feet or 2 m)	Stop at the horizontal position (with mast positioned vertically)	Not tilt forward
	Low Lift Height	Stop at the horizontal position (with mast positioned vertically)	Stop at the horizontal position (with mast positioned vertically) or up to 1° backward depending on the load
Backward tilt	High Lift Height (Over 6 feet or 2 m)	Stop at the horizontal position (with mast positioned vertically)	Stop at the horizontal position (with mast positioned vertically) or up to 1° backward depending on the load
	Low Lift Height	Stop at the horizontal position (with mast positioned vertically)	Stop at the horizontal position (with mast positioned vertically) or up to 1° backward depending on the load

⚠ CAUTION

- When you move the tilt lever forward while pressing the tilt lever knob switch or the automatic fork leveling switch, with a load at a high lift height, the mast will stop moving suddenly. Avoid such operation, because the truck may tip over.
- If the truck is equipped with an attachment, do not use automatic fork leveling with an elevated load, and the engine running at high RPM.
- A heavy attachment may affect a lift truck equipped with automatic fork leveling control. Ask the Toyota dealer before installing this type of attachment.



7 SAS FUNCTION

Active mast forward tilt angle control

This function automatically limits the forward tilt angle of the mast depending on the load weight and lift height.

	Light Load (no load)	Medium Load	Heavy Load
High Lift Height (Over 6 feet or 2 m)	No limitation for forward tilt angle	Forward tilt angle limited from 1° to 5°	Forward tilt angle limited to 1°
Low Lift Height	No limitation for forward tilt angle		

⚠ CAUTION

- This feature is intended to enhance the stability of the forklift under certain conditions, but cannot prevent the forklift from tipping forward or the load from falling off under all circumstances. You must continue to use caution when operating the forklift.
- When you lift a load from a low lift height with the mast tilted forward, the active mast forward tilt angle control does not work. Avoid such operation, because the truck may tip forward.
- Never tilt the mast beyond its vertical position with a load at a high lift height, or the truck may tip forward, losing its stability forward or backward.
- Even with a load within the allowable capacity, tilting the mast beyond its vertical position with a load elevated may cause tip-over as the center of gravity shifts forward and upward. Never tilt the mast forward when a load is elevated.
- A heavy attachment may affect a lift truck equipped with active mast forward tilt angle control. Ask the Toyota dealer before installing this type of attachment.
- Once you have replaced forks with any attachment, have the truck inspected by the Toyota dealer.
- If you use two or more removable attachments alternately, the heaviest one should be used to carry out matching (SAS setting). Ask the Toyota dealer for help in advance.
- When attaching forks or attachment to a forkless model, the attachments must be compatible with the model. Ask the Toyota dealer to request compatibility matching (SAS setting).

NOTICE

When forks are at the maximum lift height, high pressure (relief pressure) may remain in the lift cylinder. This will cause the truck to detect that it has a heavy load even if there is no load. As a result, the tilt forward angle is limited. In such case, lower the mast slightly to tilt the mast forward.

Active mast backward tilt speed control

This function automatically reduces the backward tilt speed of the mast at a lift height higher than approximately 6 feet (2 m) in order to prevent the load from shifting.

- At a high lift height, the backward tilting speed is automatically limited regardless of the load weight. When lowering from a high lift height to a lower lift height while tilting the mast backward, the tilting speed will not change.
- At a low lift height, the backward tilting speed is not limited even if there is a load. When lifting from a low lift height to a higher lift height while tilting the mast backward, the tilting speed will not change.

- When operating the tilt lever backward while pressing the tilt knob switch at any lift height, the backward tilting speed is limited as long as the tilt lever knob switch is pressed (except trucks equipped with Mini lever or Joy stick).

7.2.1 Key-lift interlock

When the key switch is turned off, the forks will not lower even if the lift lever is operated. The forks can be lowered when the operator is seated in the operator's seat and the key switch is turned on even if the engine is stopped. (Except Mini lever or Joy stick models)

7.2.2 Active steering control

If the steering wheel knob is not at the same angle as the steer tires, such out-of-position will be automatically corrected while turning the steering wheel. Thus, the knob is kept at a constant position relative to the steer tires.

7.2.3 Should a problem with SAS occur:

The truck with SAS is equipped with a controller, sensors and various switches. Should one or more of these components experience a problem, the following may occur:

- The automatic fork leveling control, active mast forward tilt angle control and/or active mast backward tilt speed control may not operate properly.
- The swing lock cylinder may be locked.
- Steering wheel knob position may not be corrected automatically even if it is out-of-position.

Should any of the above occur, you can expect the following:

- An error code will be displayed in the hour meter.



- The spanner indicator lamp will illuminate or blink.

Should one or more of these conditions occur, stop the operation in progress and park the truck in a safe location, apply the parking brake and remove the key. Then, ask the Toyota dealer for an inspection.



8 OPS FUNCTION

8.1 Precautions on OPS

(OPS: Operator Presence Sensing)

The OPS prevents powered traveling and load handling operations when the operator is not seated in the normal operating position (operator's seat).

If the operator leaves the seat while the truck is in operation, the buzzer will sound for approx. one second and the OPS indicator lamp will illuminate to inform the operator that the system is going to be activated.

If the operator remains out of the seat for 2 seconds or more, the system will be activated and stop powered travel and load handling operations. If the operator returns to the seat within 2 seconds, operation can be continued normally.

This truck is equipped with the OPS. Confirm the OPS is functioning properly before operating truck.

If an error occurs within the OPS, the spanner indicator lamp will illuminate on the display to inform the operator of the error. This indicates that there is a malfunction. Have the truck inspected by the Toyota dealer.

8.2 Description of OPS features

8.2.1 Travel OPS function

If the operator leaves the seat while the truck is traveling, the OPS indicator lamp will illuminate and powered travel will be stopped after 2 seconds.

If the operator returns to the normal seating position within 2 seconds, traveling can be continued.

The OPS will not apply the brakes to stop coasting or prevent rolling back on inclines.

To restart powered travel, release the accelerator pedal, return the direction control lever to the neutral position and sit in the seat.

Trucks with EZ pedal (Option)

To cancel the travel OPS, sit in the seat and apply the parking brake or release the accelerator pedal and press it again.

⚠ CAUTION

Travel OPS is not a brake.

OPS stops powered travel, but does not apply the brake. Apply the parking brake at all times when leaving the operator's seat.

8.2.2 Load handling OPS function

If the operator leaves the seat for 2 seconds or more during load handling operations, the OPS indicator lamp will illuminate and load handling operations will be stopped.

If the operator returns to normal seating position within 2 seconds, lowering operation can be continued.

If the operator leaves the seat while operating the control lever, lowering operation can be continued for 2 to 4 seconds.

Trucks with a standard lever

If the load handling OPS is activated when the lift lever is in the lowering position, return the lever to a neutral position and return to the normal operating position to restart load handling operation.

If the load handling OPS is activated when the lift lever is in a position other than the lowering position, the load handling OPS is deactivated 1 second after the operator returns to the normal operating position.

Trucks with Mini lever or Joy stick (Option)

To restart load handling operation, return all levers to the neutral position and return to the seat.

⚠ CAUTION

If you operate the attachment lever when the OPS is activated, the attachment might move or lower by its own weight.

8.2.3 OPS operation information function

If the operator leaves the seat, the buzzer will sound for approx. one second and the OPS indicator lamp will illuminate to inform the operator that the OPS is going to be activated.

The OPS indicator remains on until the operator returns to the seat to confirm the activation of the OPS.

8.2.4 Return-to-neutral

Traveling

When the travel OPS is activated, if the operator returns to the seat without returning the direction control lever to the neutral position, the buzzer will sound and the travel OPS cannot be deactivated.

To deactivate the travel OPS, always return the direction control lever to the neutral position, before returning to the seat.

Trucks with EZ pedal (Option)

To deactivate the travel OPS, release the accelerator pedal.

Load Handling

Trucks with a standard lever

When the load handling OPS is activated, if the operator returns to the seat without returning the lift lever to the neutral position from the lowering position, the buzzer will sound and the load handling OPS cannot be deactivated.

To deactivate the load handling OPS, always return the lift lever to the neutral position, before returning to the seat.



8 OPS FUNCTION

Trucks with Mini lever or Joy stick (Option)

If the operator returns to the seat when not all levers are in the neutral position, the buzzer will sound and the load handling OPS cannot be deactivated.

To deactivate the load handling OPS, always return all levers to the neutral position and return to the seat.

8.2.5 Parking brake on warning

If the parking brake is not released prior to travel, the parking brake on warning indicator will blink on the Multi-function display and the warning sound will warn the operator.

8.2.6 Parking brake off warning

If the operator leaves the truck or turns off the key switch without applying the parking brake, a warning sound will warn the operator.

If the operator releases the parking brake within 1 minute after turning off the key switch, a warning sound will also warn the operator.

The warning sound will stop after 30 seconds.

⚠ CAUTION

When leaving the seat, always return the control levers to the neutral position, apply the parking brake and lower the forks to the floor or ground. Then, turn off the key switch and remove the key.

8.2.7 Should a problem with OPS occur:

Should OPS experience a problem, spanner indicator lamp will blink and notify the operator. Park the truck in a safe location and ask the Toyota dealer for an inspection.

Also, in any of the following cases, a malfunction may have occurred to the OPS. Park the truck in a safe location, apply the parking brake, remove the key and ask the Toyota dealer for an inspection:

- The OPS indicator lamp does not illuminate when the operator is not seated in the normal operating position.
- The OPS indicator lamp does not go off when the operator is in the normal operating position.

⚠ CAUTION

If the operator remains seated for a long period with the key switch turned off, the next time the key switch is turned on, the spanner indicator lamp may start blinking. If this occurs, turn the key switch off, return to the normal operating position and then turn the key switch back on. The spanner indicator lamp will then go off.



9 MAIN FUNCTIONS

9.1 Travel control function

Function	Equipped Models
Maximum speed limitation	All models
Low-speed setting	Models with Multi-function Display (Option)/ Multi-function Display DX (Option)

NOTICE

Depending on the truck weight, the set speed may not be attained while traveling up a gradient or incline. Similarly, the set speed may be exceeded during travel down a gradient or incline, but will resume at the set speed when it is reached after going down the gradient or incline.

9.1.1 Low-speed Setting

This function limits the maximum travel speed to a preset value when the low-speed setting switch is pressed on the Multi-function display.

The setting value of the low-speed setting can be changed on the Multi-function display by the operator and a supervisor.

For details, refer to INSTRUMENT section of this manual.

9.1.2 Maximum Speed Limitation

This function limits the maximum travel speed to a preset value.

To change the setting of the maximum speed limitation, ask a supervisor or the Toyota dealer.

9.2 Engine auto stop function

(Option: Multi-function Display DX)

If the operator leaves the truck with the parking brake applied and without turning off the key switch for a certain amount of time, the engine and the power will be stopped automatically, thus preventing the waste of fuel.

To restart the truck, turn off the key switch, and then turn it back on. Your truck has an anti-restart ignition key switch to protect the engine, so you must turn the switch from the ON position to the OFF position before attempting to start the engine again.

To change the setting time of the engine auto stop function, ask a supervisor or the Toyota dealer.

⚠ CAUTION

When leaving the seat, always return the control levers to the neutral position, apply the parking brake and lower the forks to the floor or ground. Then, turn off the key switch and remove the key.

NOTICE

- When the Engine auto stop function is activated, the Key off head light off system will also be activated in order to save power and prevent the battery over discharge. For details, refer to Key off head light off system section of this manual.
- This function may not be activated during engine warm-up.

9.3 Eco-mode

(Option: Multi-function Display/ Multi-function Display DX)

When the eco-mode is active, traveling and load handling acceleration is limited, in order to assist with the improvement in fuel consumption.

This function can be turned on/off on the Multi-function display. For details, refer to INSTRUMENT section of this manual.

To change the setting value of the acceleration limit, ask the Toyota dealer.



10 SWITCHES AND LEVERS

10 SWITCHES AND LEVERS

10.1 Ignition key switch

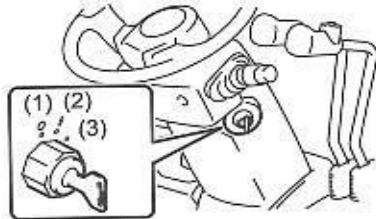

- (1) OFF
- (2) ON
- (3) START

OFF - Position to stop the engine. Insert/withdraw the key in this position.

ON - Engine operating position. Located one position clockwise from the OFF position.

START - Position to start the engine. Located one position clockwise from the ON position.

To start the engine, turn the key switch to START position. After the engine starts, release the key and it will return to the ON position automatically. To restart the engine, turn back the key switch to OFF position, and turn it to START position.

The engine does not start unless the direction control lever is in the neutral position.

For trucks with EZ pedal (Option), the engine does not start unless the parking brake is applied or the accelerator pedal is released.

⚠ WARNING

- When you turn on the key switch, be sure that you are in the normal operating position with the seat belt fastened and the parking brake is applied. Otherwise, the truck may start suddenly, leading to an unexpected accident.
- If the OPS indicator lamp is illuminated, return the direction control and load handling control levers to the neutral positions and sit in the seat. Confirm that the OPS indicator lamp is not illuminated.
- When starting 1FS engine models (gasoline/ LPG), do not press the accelerator pedal.
- Do not leave the key switch in the ON position when the engine is stopped. It will cause the battery to over discharge.
- Do not operate the starter motor for more than 30 seconds continuously. Return the switch to the OFF position and wait at least 30 seconds prior to attempting restart.
- Do not turn the switch to the START position while the engine is running (except trucks fitted with optional anti-restart ignition key switch). This may damage the starter motor.
- If your truck has an anti-restart ignition key switch to protect the engine, you must turn the switch from the ON position to the OFF position before attempting to start the engine again.
- When the key switch is turned off (engine stopped), the forks will not lower even if the lift lever is operated. The forks can be lowered when the operator is seated in the operator's seat and key switch is turned on (Key-lift interlock) (Except Mini lever and Joy stick models).
- If the spanner indicator lamp is illuminated and does not go off when you sit in the seat, the battery voltage may be low (over discharged). In such case, do not operate the truck until the indicator lamp turns off, because the truck may not operate correctly. If the spanner indicator lamp does not go off approximately 1 to 2 minutes after

engine starts or when the engine speed is increased, stop operation and have the truck inspected by the Toyota dealer. (For diesel engine models, the spanner indicator lamp may stay illuminated during engine warm-up after a cold engine start. This does not indicate a malfunction.)

NOTICE

- For diesel engine models, start the engine after the glow indicator lamp goes off.

10.2 Direction control lever

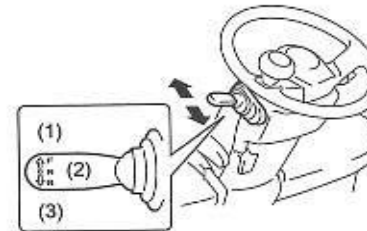

- (1) Forward
- (2) Neutral
- (3) Reverse

Shift lever to change the travel direction between forward and reverse.

Forward travel - Push the lever forward

Reverse travel - Pull the lever backward

The neutral position is halfway between the forward and reverse position.

Forward and reverse travel speed can be adjusted by the amount the accelerator pedal is depressed.

⚠ CAUTION

- Always operate the direction control lever from a normal operating position.
- The engine cannot be started unless the direction control lever is in the neutral position.
- Stop the truck before shifting between forward and reverse direction.

NOTICE

To restart powered travel after the activation of the OPS, release the accelerator pedal, return the direction control lever to the neutral position and sit in the seat. Sitting in the seat without returning the direction control lever to the neutral position will not allow powered travel.



10.3 Torque converter interlock function (Option)

If you move the direction control lever to change travel direction (i.e. forward to reverse direction) while traveling at high speed, this function electrically disengages the drive and sets the torque converter to neutral. Once the speed drops below the set speed while traveling in neutral, the travel direction will be automatically switched.

To change travel direction, operate the direction control lever after travel speed is reduced sufficiently.

Ask the Toyota dealer about changing the speed setting.

⚠ CAUTION

- When the interlock is engaged, release the accelerator pedal and use the brake pedal to reduce speed. After the truck has stopped moving, slowly press the accelerator pedal down to start moving again. Disengaging the interlock while the accelerator pedal is pressed down could result in wheel spin.
- Do not perform forward or reverse operation on a gradient or incline. If direction control lever is operated on a down gradient or incline, the torque converter interlock function may not operate correctly.

10.4 Parking brake lever

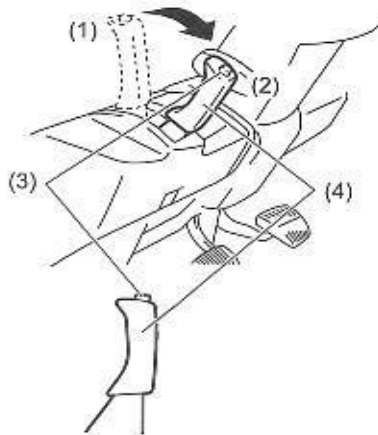

- (1) Released
- (2) Locked
- (3) Release knob button
- (4) Grip

Use the parking brake lever when parking or stopping.

Applying the parking brake

Grasp the grip of the parking brake lever and fully pull it toward you while depressing the brake pedal.

Releasing the parking brake

Push back the lever while pressing the release knob button. Keep the brake pedal fully depressed.

⚠ WARNING

- Before applying the parking brake, depress the brake pedal and always confirm that the truck has come to a stop.
- Never hold the lever at other than the grip because a finger may be pinched. Hold the grip at above the protrusion.
- Do not park the truck on a slope. Always park on level ground with forks flat on the floor so that no one will run into them or trip over them. If parking on a slope is unavoidable, place blocks behind the wheel to prevent the truck from rolling.
- Traveling without releasing the brake will damage the truck and brakes.
- If the parking brake is engaged when the direction control lever is in traveling position, the parking brake on warning indicator on the Multi-function display will blink and a warning will sound to warn the operator (Option: Multi-function display). If the truck is operated without disengaging the parking brake, the brakes will lose effectiveness to hold the truck when the parking brake is applied. Ask the Toyota dealer for an inspection.
- If the operator leaves the truck or turns off the key switch without engaging the parking brake, a warning will sound to warn the operator. When leaving the seat, always apply the parking brake, turn the key switch off and remove the key.



10 SWITCHES AND LEVERS

10.5 Lift lever



- (1) Lower
- (2) Lift
- (3) Lift lever

⚠ WARNING

- Always operate the lift lever from a normal operating position.
- If the OPS is activated, fully release the accelerator pedal, return the lift lever to the neutral position and return to the normal operating position to deactivate the OPS. If you return to the seat while the lift lever is in the lifting position, the OPS will be deactivated and the forks will start moving 1 second later.
- After the OPS is activated, if you return to the normal operating position while the lift lever is in the lowering position, the OPS will not be deactivated and the forks will not move due to the return-to-neutral function. Always return the lift lever to the neutral position before returning to the seat when deactivating the OPS.
- As long as the engine is off, the forks will not lower even if the lever is moved to the lowering position. When you sit in the normal operating position and turn the key switch to ON position, you can lower the forks even if the engine is stopped (except trucks with optional Mini lever or Joy stick).

Lever to lift and lower the forks.

Lower - Push the lever forward

Lift - Pull the lever backward

The lifting speed can be adjusted by the amount the accelerator pedal is depressed and the amount the lift lever is pulled backward.

The lowering speed can be adjusted only by the amount the lift lever is pushed forward.

10.6 Manual lowering valve

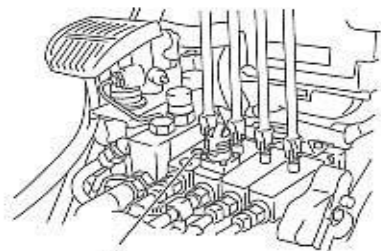

(1)

- (1) Manual lowering valve

If the key switch cannot be turned on for whatever reason and the forks cannot be lowered, loosen the manual lowering valve located on the oil control valve beneath the floor board, and move the lift lever to the lowering position.

NOTICE

Once the forks have been lowered with the manual lowering valve, be sure to close and lock the valve.

10.7 Tilt lever

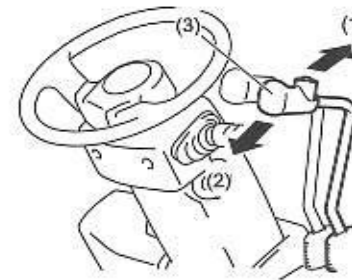

- (1) Forward tilt
- (2) Backward tilt
- (3) Tilt lever

⚠ WARNING

- Always operate the tilt lever from a normal operating position.
- If the OPS is activated, fully release the accelerator pedal, return the tilt lever to the neutral position and return to the normal operating position to deactivate the OPS. If you return to the seat while the tilt lever is operated, the OPS will be deactivated and the forks will start moving 1 second later.

Lever to tilt the mast forward and backward.

Forward tilt - Push the lever forward

Backward tilt - Pull the lever backward

The forward or backward tilting speed can be adjusted by the amount the accelerator pedal is depressed and the amount the tilt lever is moved.

10.8 Tilt lever knob switch

(Automatic fork leveling control)

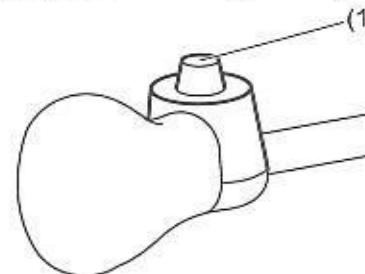

- (1) Tilt lever knob switch

Forks will automatically stop at the horizontal position when operating the tilt lever from backward to forward position with pressing the tilt lever knob switch.

It is also possible to slow down the backward tilting speed at a low lift height by pressing the knob switch (At a high lift height, the backward tilting speed is automatically reduced by the active mast backward tilt speed control function of SAS).

For details of this function, please refer to the SAS FUNCTION section of this manual.



10.9 Clamp release button (Option)

(only with Clamp release interlock option)

Standard lever

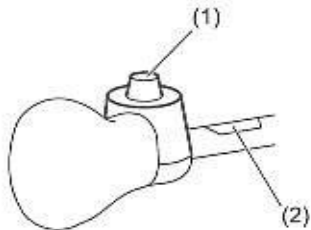

The clamp release lever is fitted on the attachment lever (clamp operating lever). To open the clamp attachment, operate the attachment lever forward with the clamp release switch pressed.

Mini lever (Option)

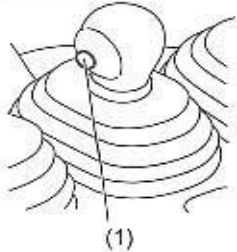

- (1) Clamp release button
- (2) Clamp release decal



10.10 Mini lever (Option)

10.10.1 Direction control lever

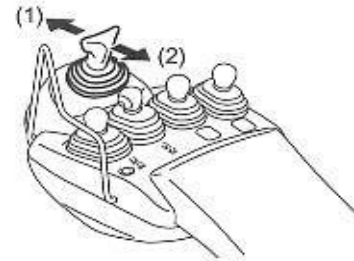

Shift the lever to change the travel direction between forward and reverse.

Forward travel - Push the lever forward

Reverse travel - Pull the lever backward

The neutral position is halfway between the forward and backward position.

Forward and reverse travel speed can be adjusted by the amount the accelerator pedal is depressed.

- (1) Forward travel
- (2) Reverse travel

⚠ CAUTION

- Always operate the direction control lever from a normal operating position.
- The engine cannot be started unless the direction control lever is in the neutral position.
- Stop the truck before shifting between forward and reverse.

NOTICE

- To restart powered travel after the activation of OPS, release the accelerator pedal, return the direction control lever to the neutral position and sit in the seat. Sitting in the seat without returning the direction control lever to the neutral position will not allow powered travel.
- The position of the direction control lever may vary depending on the truck specifications.

10 SWITCHES AND LEVERS

10.10.2 Lift lever

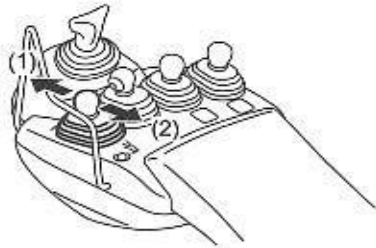

- (1) Lower
- (2) Lift

⚠ WARNING

- Always operate the lift lever from a normal operating position.
- If the OPS is activated, fully release the accelerator pedal, return all levers to the neutral position and return to the normal operating position to deactivate the OPS.
- After the OPS is activated, if you return to the normal operating position while the lever(s) are operated, the OPS will not be deactivated and the forks will not move due to the return-to-neutral function. Always return all levers to the neutral position before returning to the seat when deactivating the OPS.

Lever to lift and lower the forks.

Lower - Push the lever forward

Lift - Pull the lever backward

The lifting speed can be adjusted by the amount the accelerator pedal is depressed and the amount the lift lever is pulled backward.

The lowering speed can be adjusted only by the amount the lift lever is pushed forward.

10.10.3 Tilt lever



- (1) Forward tilt
- (2) Backward tilt

Lever to tilt the mast forward and backward

Forward tilt - Push the lever forward

Backward tilt - Pull the lever backward

The forward or backward tilting speed can be adjusted by the amount the accelerator pedal is depressed and the amount the tilt lever is moved.

⚠ WARNING

- Always operate the tilt lever from a normal operating position.
- If the OPS is activated, fully release the accelerator pedal, return all levers to the neutral position and return to the normal operating position to deactivate the OPS.
- After the OPS is activated, if you return to the normal operating position while the lever(s) are operated, the OPS will not be deactivated and the forks will not move due to the return-to-neutral function. Always return all levers to the neutral position before returning to the seat when deactivating the OPS.

10.10.4 Automatic fork leveling switch

(Automatic fork leveling control)

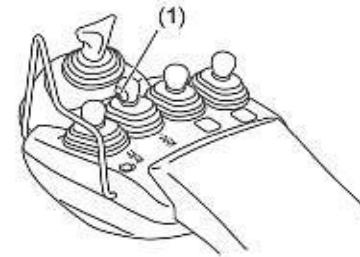

- (1) Automatic fork leveling switch

Forks will automatically stop at the horizontal position when operating the tilt lever from the backward to forward position or from the forward to backward position while pressing the automatic fork leveling switch.

It is also possible to slow down the backward tilting speed at a low lift height by pressing this switch (At a high lift height, the backward tilting speed is automatically reduced by the active mast backward tilt speed control function of SAS).

For details of this function, please refer to the SAS FUNCTION section of this manual.

10.10.5 Attachment lever

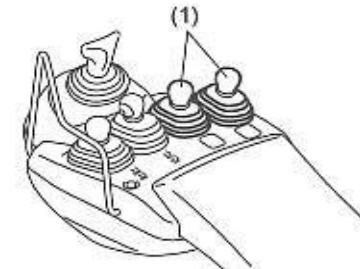

- (1) Attachment levers

Levers to operate attachments.

Attachment operating speed can be adjusted by the amount the accelerator pedal is depressed and the amount the levers are moved.



⚠ WARNING

- Always operate the attachment levers from a normal operating position.
- If the OPS is activated, fully release the accelerator pedal, return all levers to the neutral position and return to the normal operating position to deactivate the OPS.
- After the OPS is activated, if you return to the normal operating position while the lever(s) are operated, the OPS will not be deactivated and the forks will not move due to the return-to-neutral function. Always return all levers to the neutral position before returning to the seat when deactivating the OPS.

10.10.6 Horn switch

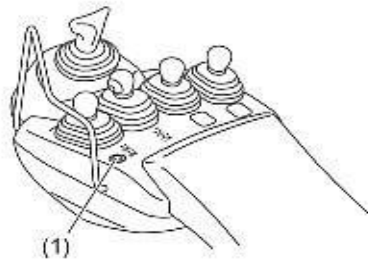

(1) Horn switch

Press this switch to sound the horn.

10.11 Joy stick (Option)

10.11.1 Direction control lever



(1) Forward travel
(2) Reverse travel

Shift the lever to change the travel direction between forward and reverse.

Forward travel - Push the lever forward

Reverse travel - Pull the lever backward

The neutral position is halfway between the forward and backward position.

Forward and reverse travel speed can be adjusted by the amount the accelerator pedal is depressed.

⚠ CAUTION

- Always operate the direction control lever from a normal operating position.
- The engine cannot be started unless the direction control lever is in the neutral position.
- Stop the truck before shifting between forward and reverse.

NOTICE

- To restart powered travel after the activation of OPS, release the accelerator pedal, return the direction control lever to the neutral position and sit in the seat. Sitting in the seat without returning the direction control lever to the neutral position will not allow powered travel.
- The position of the direction control lever may vary depending on the truck specifications.

10.11.2 Load handling lever

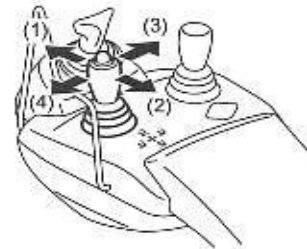

(1) Forward tilt
(2) Backward tilt
(3) Lift
(4) Lower

Lever to tilt the mast forward and backward and lift and lower the forks.

Forward tilt - Push the lever forward

Backward tilt - Pull the lever backward

The forward or backward tilting speed can be adjusted by the amount the accelerator pedal is depressed and the amount the lever is moved.

Lift - Push the lever to the right

Lower - Push the lever to the left

The lifting speed can be adjusted by the amount the accelerator pedal is depressed and the amount the lever is moved.

The lowering speed can be adjusted only by the amount the lever is moved.

⚠ WARNING

- Always operate the load handling lever from a normal operating position.
- If the OPS is activated, fully release the accelerator pedal, return all levers to the neutral position and return to the normal operating position to deactivate the OPS.
- After the OPS is activated, if you return to the normal operating position while the lever(s) are operated, the OPS will not be deactivated and the forks will not move due to the return-to-neutral function. Always return all levers to the neutral position before returning to the seat when deactivating the OPS.

10 SWITCHES AND LEVERS

10.11.3 Automatic fork leveling switch
(Automatic fork leveling control)

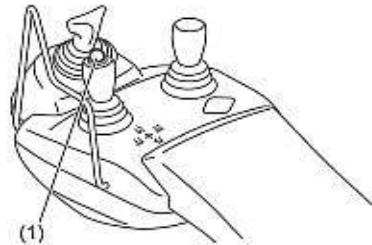

(1) Automatic fork leveling switch

Forks will automatically stop at the horizontal position when operating the load handling lever from the backward to forward position or from the forward to backward position while pressing the automatic fork leveling switch. It is also possible to slow down the backward tilting speed at a low lift height by pressing this switch (At a high lift height, the backward tilting speed is automatically reduced by the active mast backward tilt speed control function of SAS).

For details of this function, please refer to the SAS FUNCTION section of this manual.

10.11.4 Attachment lever



Lever to operate attachments. Attachment operating speed can be adjusted by the amount the accelerator pedal is depressed and the amount the lever is moved.

⚠ WARNING

- Always operate the attachment lever from a normal operating position.
- If the OPS is activated, fully release the accelerator pedal, return all levers to the neutral position and return to the normal operating position to deactivate the OPS.
- After the OPS is activated, if you return to the normal operating position while the lever(s) are operated, the OPS will not be deactivated and the forks will not move due to the return-to-neutral function. Always return all levers to the neutral position before returning to the seat when deactivating the OPS.

10.12 Arm rest (Mini lever or Joy stick models)

Mini lever

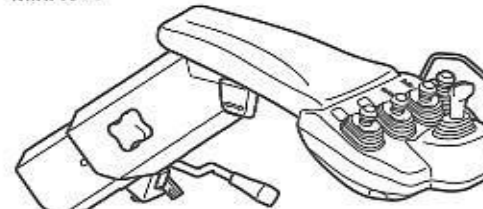

Joy stick

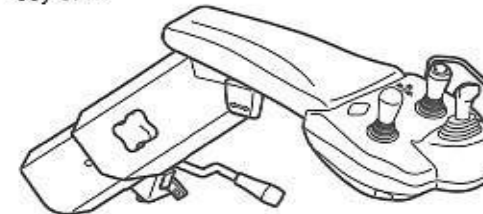

Before starting the engine, adjust the arm rest to set the optimum driving position.

⚠ CAUTION

- Do not adjust the arm rest position while the truck is moving.
- After the adjustment of the arm rest position, confirm that the knobs and the lever have been secured in place. A loose knob or lever may cause an accident.
- To operate the truck safely, lock the arm rest securely. Before operating the truck, always confirm that the lever for turning and securing the arm rest is locked.

Adjusting the forward-backward position

1. Pull up and loosen the forward-backward position adjustment knob.
2. Adjust the arm rest forward-backward position.
3. Then press the knob, securing the arm rest position in place.

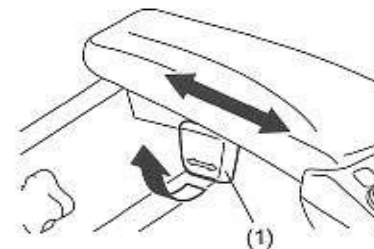

(1) Forward-backward position adjustment knob

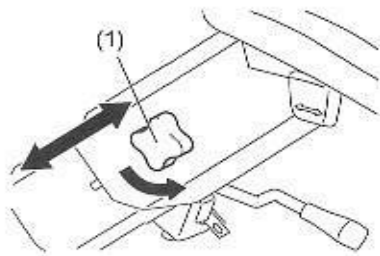

(1) Height adjustment knob

Adjusting the height position

1. Turn the height adjustment knob counter-clockwise to release the lock.
2. Then, move the arm rest up-and-down to place it to a desired position.
3. Turn knob clockwise to lock.

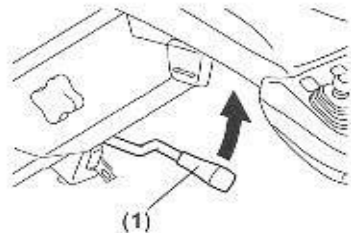

(1) Lever for turning and securing the arm rest

Tilt adjustment

1. Pull up and loosen the lever for turning and securing the arm rest.
2. Adjust the tilt of the arm rest.
3. Then push the lever down, securing the arm rest position in place. This lever is also used in order to turn the arm rest when you open and close the engine hood.

10.13 Integrated light and turn signal switch

This switch serves as both two-position light control switch and turn signal switch.

Light control switch

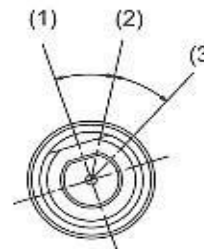

- (1) OFF
(2) Position 1
(3) Position 2

Irrespective of the key switch position, this switch allows you to turn the lights on or off.

NOTICE

For models with Multi-function display DX (Option) or Key off head light off system (Option), the lights can be turned on only when the key switch is in the ON position.

This switch has two positions. With the switch at each position, the lights come on as shown below.

Light name	Position 1	Position 2
Head lights	OFF	ON
Tail lights, clearance lights (Option)	ON	ON
Meter illumination light	ON	ON

⚠ CAUTION

Do not keep lights such as the head lights on for a long time when the engine is stopped. It may cause over discharge of the battery and makes engine starting impossible.



10 SWITCHES AND LEVERS

Turn signal switch

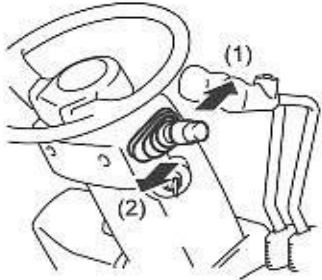

- (1) Left turn
- (2) Right turn

This is a switch to make turn signal lights blink.

Left turn - Push forward

Right turn - Pull backward

The signal switch operates when the key switch is turned on.

The turn signal lever returns automatically to the original position after making a direction change.

10.14 Key off head light off system (Option)

The following lights will be turned off automatically when turning off the key switch.

- Head lights
- Clearance lights of the front combination light (Option)
- Tail lights of the rear combination light (Option)

The following lights will not be turned off by Key off head light off system.

- Interior lamp (Option: Cabin models)
- Rear working light (Option)
- Stop light of the rear combination light

10.15 Rear working light (Option)

Rear working light

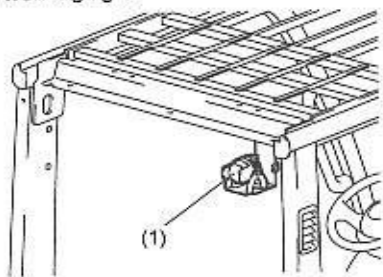

- (1) Rear working light

Rear working light is fitted to the right rear of the overhead guard (to the left rear for models with optional Pre-cleaner).

Switch

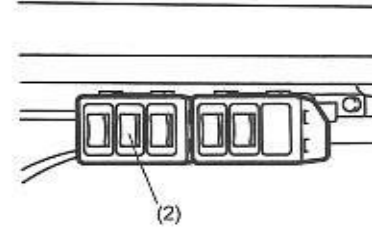

(2) Rear working light switch

Rear working light switch



Rear working light switch (Selective lighting condition)



Rear working light switch

ON- Upper position

OFF- Lower position

Rear working light switch (Selective lighting condition)

ON- Upper position

OFF- Center position

BACK ON- Lower position

When the switch is at BACK ON position, light turns on only when the direction control lever is placed in reverse position.



10.16 Horn button

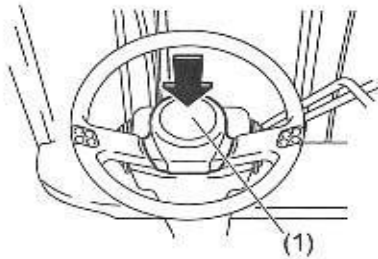

(1) Horn button

Press the button in the center of the steering wheel to sound the horn.
The horn will sound even when the key switch is turned off.

NOTICE

- Do not operate the horn continuously more than 3 minutes. This may result in a malfunction.
- Do not operate the horn frequently more than necessary. This may result in a malfunction.

10.17 Rear assist grip with horn button (Option)

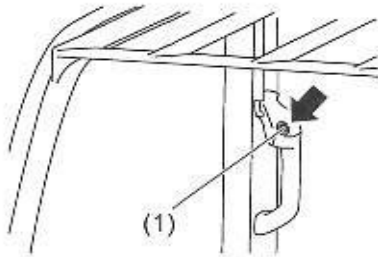

(1) Horn button

Press the button on the rear assist grip to sound the horn. Use this horn when reversing.
The horn will sound even when the key switch is turned off.

10.18 Tilt steering adjusting lever



(1) Tilt steering adjusting lever

The steering wheel position can be adjusted back and forth by the following procedure.

1. Pull the tilt steering adjusting lever up.
2. Adjust the steering wheel to the desired position.
3. Lock the steering wheel position by pushing down the lever.
4. After adjustment, try to move the steering wheel back and forth to make sure it is locked.

⚠ WARNING

- Always adjust the steering wheel position before traveling. Do not adjust the steering wheel position while the truck is moving. It may lead to incorrect operation and cause an unexpected accident.
- After adjustment, lightly shake the steering wheel back and forth to make sure it is locked securely. Otherwise, the steering wheel could move during operation, causing an accident.

10.19 Telescopic steering (Option)

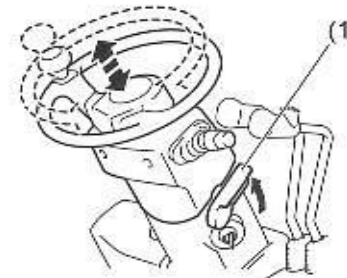

(1) Height adjustment lever

Use the telescopic steering to adjust the height of the steering wheel.

1. Pull the height adjustment lever up.
2. Hold the steering wheel with both hands, and adjust the height.
3. Hold the height adjustment lever down at the desired position, and lock the steering wheel securely. The steering wheel will be locked.
4. After adjustment, try to move the steering wheel back and forth to make sure it is locked.

⚠ WARNING

- Do not adjust the steering wheel position while the truck is moving. It may lead to incorrect operation and cause an unexpected accident.
- After adjustment, lightly shake the steering wheel back and forth to make sure it is locked securely. Otherwise, the steering wheel could move during operation, causing an accident.

10 SWITCHES AND LEVERS

10.20 Accelerator pedal

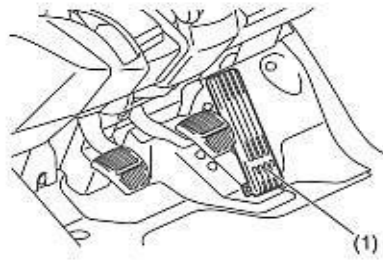

(1) Accelerator pedal

CAUTION

To avoid an unintended start of the truck, do not depress the accelerator pedal suddenly. Particularly when loaded or when stacking, the load may fall or collapse due to a sudden start. Always depress the accelerator pedal slowly.

10.21 Brake pedal

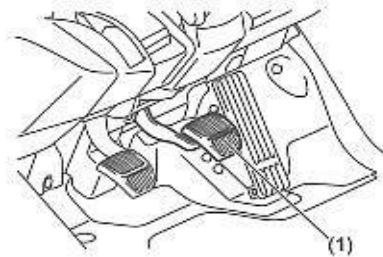

(1) Brake pedal

CAUTION

- Avoid sudden stop. Sudden stop will make the truck unstable and it may cause the truck to tip-over.
- The brake feeling differs between loaded and unloaded truck. Adjust the amount the brake pedal is depressed according to the loading state.

Pedal to control the engine speed. The engine speed can be adjusted by the amount the accelerator pedal is depressed. Use the accelerator pedal to adjust the travel speed and the load handling speed.

Pedal to make a truck slow down or stop.

10.22 Inching pedal

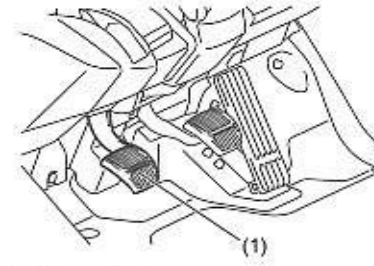

(1) Inching pedal

CAUTION

- To come to a stop, always use the brake pedal. Depressing the inching pedal will disengage the transmission and the engine braking will not work.
- When starting the truck on a slope or traveling down a slope, do not use the inching pedal. The use of the inching pedal disables the engine braking and it becomes hard to brake the truck safely.

Pedal used to make fine adjustment of the travel speed.

Depressing the inching pedal slightly will partially disengage the transmission and make the truck move slowly. Fully depressing the inching pedal will completely disengage the transmission and bring the truck to a complete stop.

Operating the inching pedal

To slowly start the truck to the forward or reverse direction, follow the next procedure.

1. Fully depress the inching pedal.
2. Operate the direction control lever to the forward or reverse position.
3. Gradually depressing the accelerator pedal and releasing the inching pedal at the same time will start the truck slowly.

10.23 EZ pedal (Option)

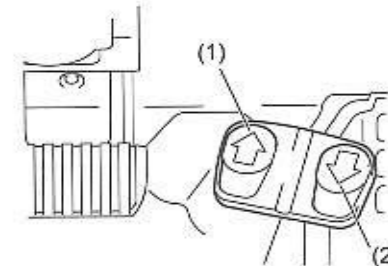

(1) Forward travel

(2) Reverse travel

The EZ pedal is the accelerator pedal which also has the direction-control function.

Forward travel - Depress the left side of the pedal.

Reverse travel - Depress the right side of the pedal.

The traveling speed is adjusted by the amount the pedal is depressed.

NOTICE

- The engine can be started only when the parking lever is applied or the accelerator pedal is released, and the direction is in the neutral position.
- After the OPS is activated, the OPS can be canceled by sitting in the seat and applying the parking brake or releasing the accelerator pedal and pressing it again.



10.24 Gear lock switch (Option)

(Not available on 1 speed Transmission)

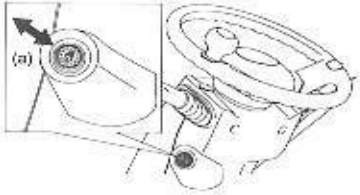

To activate or deactivate the gear lock switch, press the switch once.

(a) ON/OFF

NOTICE
This is not a gear selector.

In case of Telescopic Steering

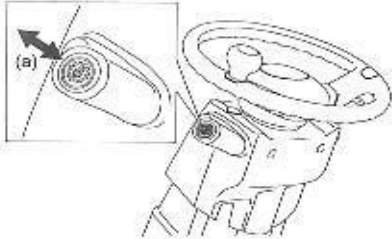

Indicator Status	Description
ON (Light ON)	Truck is locked in first gear.
OFF (Light OFF)	Truck can be in first or second gear.
Light Flashing	Conditions are not met for locking the truck in first gear.

⚠ CAUTION

- Even if the gear lock switch is pressed during running in 2nd gear, the 1st gear lock function will not be activated. After that, the gear lock lamp blinks for a several seconds. By decelerating and running in 1st gear while the lamp is blinking, the 1st gear lock function will be activated and the gear lock lamp will light.
- If you keep running in the 2nd gear, the gear lock lamp turns off after a few seconds and return to the state before pressing the switch.

11 BODY COMPONENTS

11 BODY COMPONENTS

11.1 Operator's seat

ORS seat (ORS: Operator Restraint System)



(1) Seat belt

⚠ WARNING

To avoid accidents, adjust the seat position before operating the truck. Never adjust your seating position while the truck is moving.

⚠ CAUTION

- The OPS seat switch prevents powered traveling and load handling operations when the operator is not seated in the seat. Be sure to remain seated in the seat while in operation. Do not operate the truck with any objects placed on the seat.
- Do not bypass the seat switch by any method other than sitting on the seat.

A specially designed operator's seat and seat belt are provided for your safety. Get in the habit of using the seat belt whenever you sit on the truck. You can adjust the forward/backward seat position and the reclining angle of this seat. Adjust the seat position so that you can depress all pedals fully with your back leaning against the backrest of the operator's seat.

Adjusting the operator's seat position

1. Lift the seat slide lever to adjust the seat back and forth.
2. Release the lever and the seat position is fixed.
3. After adjustment, lightly shake the seat back and forth to make sure it is locked securely.



(1) Seat side lever

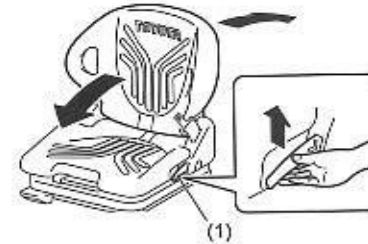

(1) Recliner adjustment lever

Adjusting the reclining angle of the operator's seat

1. Pull the recliner adjustment lever to adjust the angle of the backrest.
2. Release the lever and the backrest position is fixed.
3. Lightly shake the seat back and forth to make sure it is locked securely.

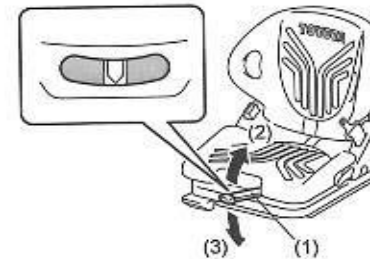

- (1) Weight adjustment lever
- (2) Upward (Lighter)
- (3) Downward (Heavier)

Adjusting the suspension seat weight

1. Fold out the weight adjustment lever completely.
2. Hold the lever at the front and move it upwards or downwards (10 movements from minimum to maximum)
3. When you have set the weight, bring the lever back to the starting position. The operator's weight has been set correctly, when the arrow is in the middle of the viewing window.

NOTICE

- When the minimum/maximum has been reached, you can notice an empty movement in the handle.
- When you have set the weight, always fold the lever completely into the locking.

Operator's manual pocket

An Operator's Manual and Manual for Safe Operation are located behind the seat. If your truck does not have a manual, ask the Toyota dealer for a copy.

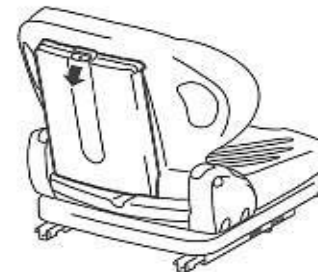

11.2 Swivel seat (Option)

Standard models

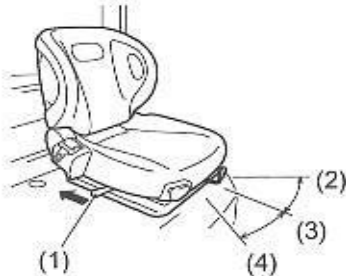

Mini lever and Joy stick models (Option)

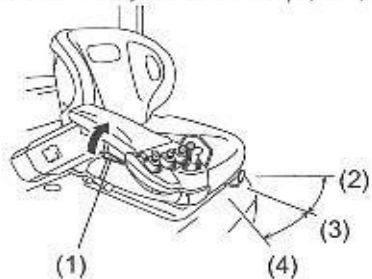

- (1) Lock release lever
- (2) Getting off position (no lock)
- (3) Normal traveling position (with lock)
- (4) Traveling in reverse position (with lock)

The swivel seat is useful when traveling in the reverse direction over long distances or when getting off the truck. The seat can be rotated to right and left by releasing the lock release lever attached to the seat.

Traveling in reverse (rotating the seat to the right)

1. For standard models, pull the release lever backward to release the lock.
For Mini lever and Joy stick models (option), pull the lock release lever upward to release the lock.
2. Rotate the seat to the right and release the lever to lock the seat.

NOTICE

Release the lock release lever once the seat starts to rotate.

3. After traveling in reverse, release the lever and return the seat to normal position.

Getting off the truck (rotating the seat to the left)

1. For standard models, pull the release lever backward to release the lock.
For Mini lever and Joy stick models (option), pull the lock release lever upward to release the lock.
2. Rotate the seat to the left when getting off the truck. The seat will not be locked into place when rotating to the left.

NOTICE

Release the lock release lever once the seat starts to rotate.

⚠ CAUTION

- When rotating the seat, be careful not to get your hand caught between the seat and cab.
- After rotating the swivel seat, return the seat to normal position and confirm that the seat is locked in place.
- While operating the truck forward or in reverse, make sure that the seat is securely locked.
- To prevent accidents, do not rotate the seat while operating the truck.
- The seat will not be locked into place when rotating to the left.

11.3 Comfort seat (Option: High overhead guard/ Premium cabin)



(1) Seat belt

⚠ WARNING

To avoid accidents, adjust the seat position before operating the truck. Never adjust your seating position while the truck is moving.

⚠ CAUTION

- The OPS seat switch prevents powered traveling and load handling operations when the operator is not seated in the seat. Be sure to remain seated in the seat while in operation. Do not operate the truck with any objects placed on the seat.
- Do not bypass the seat switch by any method other than sitting on the seat.



(1) Headrest

A specially designed operator's seat and seat belt are provided for your safety.

Get in the habit of using the seat belt whenever you sit on the truck.

You can adjust the forward/backward seat position and the reclining angle of this seat. Adjust the seat position so that you can depress all pedals fully with your back leaning against the backrest of the operator's seat.

Adjusting the headrest position

The headrest height can be adjusted by it sliding up and down.

11 BODY COMPONENTS



(1) Seat slide lever

Adjusting the operator's seat position

1. Lift the seat slide lever to adjust the seat back and forth.
2. Release the lever and the seat position is fixed.
3. After adjustment, lightly shake the seat back and forth to make sure it is locked securely.



(1) Lumbar adjustment knob

Adjusting the lumbar support

To adjust the lumbar support, turn the lumbar adjustment knob clockwise ((+) direction) increases the supporting power and counter-clockwise ((-) direction) decreases it.

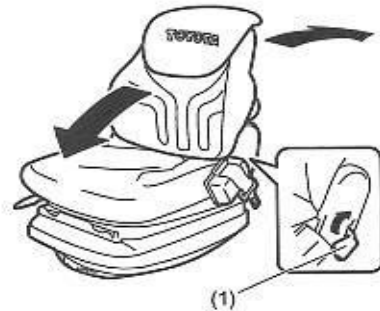

(1) Recliner adjustment lever

Adjusting the reclining angle of the operator's seat

1. Pull the recliner adjustment lever to adjust the angle of the backrest.
2. Release the lever and the backrest position is fixed.
3. Lightly shake the seat back and forth to make sure it is locked securely.



Adjusting the height

To raise the operator's seat position, raise the seat to the required height until it audibly latches into place. When the seat is raised above the highest setting (endstop) it drops back down to the lowest position.



(1) Weight adjustment lever
(2) Indicator

Adjusting the suspension seat weight

To adjust the seat for the operator's weight, turn the weight adjustment lever with the seat empty.

The set weight can be read from the indicator.

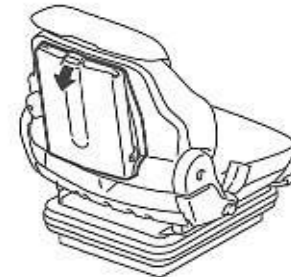

Operator's manual pocket

An Operator's Manual and Manual for Safe Operation are located behind the seat. If your truck does not have a manual, ask the Toyota dealer for a copy.



11.4 Seat belt

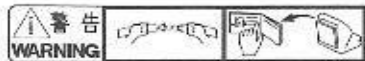
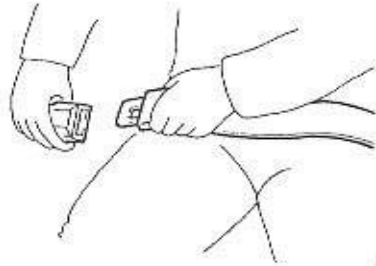

⚠ WARNING

- Always wear your seat belt when operating the truck. The truck can tip over if operated improperly. To protect operators from the risk of serious injury or death in the event of a tip over, it is best to be held securely in the seat. The seat and seat belt will help to keep you safely within the truck and operator's compartment. In the event of a tip over, don't jump, grip the steering wheel, brace your feet, lean away from the direction of tip over, and stay with the truck.
- Before fastening the seat belt, check its bracket and belt itself for any abnormal condition.
- Do not fasten the seat belt if it is twisted.
- Wear the seat belt at the lowest possible part of the hip bone tightly.
- Do not adjust the seat belt so it is loose on the body by adding slack purposely with a clip or the like.
- If the seat belt is exposed to a strong impact in an accident, the belt may be damaged or torn. As such seat belt can not perform its intended function, replace it.
- If the seat belt is damaged, do not use the forklift until it is repaired.

Fastening the seat belt

1. To fasten your seat belt, pull it out of the retractor and insert the tongue into the buckle.
2. You will hear a click when the tongue locks into the buckle. Pull on the belt to make sure the buckle is securely latched. The seat belt length will be automatically adjusted to your size.

Disconnecting the seat belt

To release the lock, press the red button at the mouth of the buckle. The belt will be automatically retracted into the retractor.

11.5 Engine hood

11.5.1 Except Mini lever or Joy stick models



(1) Engine hood lock release lever

⚠ WARNING

Working on the engine without locking of the hood may be hazardous.

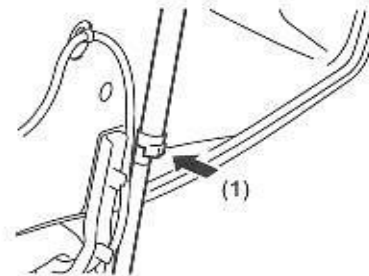

(1) Hood damper lock

Opening

1. Pull up the seat slide lever and slide the seat to the forward-most position. (Applicable models: 3.5-4.0 ton models/ Models with optional Cabin)
2. Pull up on the engine hood lock release lever to release the engine hood lock. The engine hood will pop up slightly.
3. Lift the engine hood.
4. Open the engine hood all the way, then shake the hood slightly to check that the hood damper has been securely locked before letting go.

Closing

1. Lift up the engine hood and press the hood damper lock to release the lock.
2. Close the engine hood gently, and press down on the hood until you hear a clicking sound.

11 BODY COMPONENTS

11.5.2 Mini lever and Joy stick models

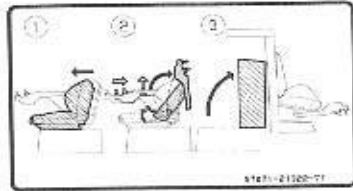

Opening (Models with Mini lever or Joy stick)

1. Pull up the seat slide lever and slide the seat to the forward-most position.
2. Pull up the forward-backward position adjustment knob and adjust the armrest to proper forward/backward position. Return the forward-backward position adjustment knob to its prior position and lock it in place.
3. Pull up on the lever for turning and securing the armrest and raise the armrest. Lower the lever for turning and securing the armrest to lock the armrest in place.
4. Pull up on the engine hood lock release lever to release the engine hood lock. The engine hood will pop up slightly.
5. Lift the engine hood.
6. Open the engine hood all the way, then shake the hood slightly to check that the hood damper has been securely locked before letting go.



Opening (Models with Cabin + Mini lever or Joy stick)

1. Pull up the seat slide lever and slide the seat to the forward-most position.
2. Pull up on the lever for turning and securing the armrest and tilt the armrest downward. Lower the lever for turning and securing the armrest to lock the armrest in place.
3. Pull up on the engine hood lock release lever to release the engine hood lock. The engine hood will pop up slightly.
4. Lift the engine hood.
5. Open the engine hood all the way, then shake the hood slightly to check that the hood damper has been securely locked before letting go.

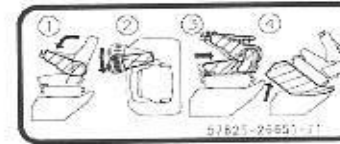

Opening (Models with +75 mm overhead guard + Mini lever or Joy stick)

1. Lift the recliner adjustment lever and recline the seat to the forward-most position.
2. Move the armrest to the inward side.
3. Pull up the seat slide lever and slide the seat to backward.
4. Lift the engine hood.
5. Open the engine hood all the way, then shake the hood slightly to check that the hood damper has been securely locked before letting go.

⚠ WARNING

Working on the engine without locking of the hood may be hazardous.

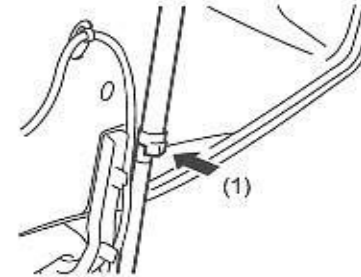

(1) Hood damper lock

Closing

1. Lift up the engine hood and press the hood damper lock to release the lock.
2. Close the engine hood gently, and press down on the hood until you hear a clicking sound.
3. Return the seat and arm rest to the normal position.

11.6 Lifting points

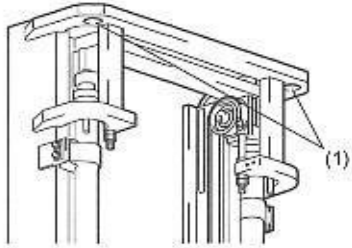

(1) Lifting points (Outer mast)

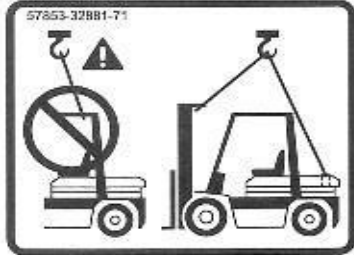

⚠ WARNING

- When lifting the truck at lifting points, be sure to use wire cable or strap that has plenty of strength. For the weight of the truck, refer to Truck weight section of this manual.
- Never use a cable that has kinks, distortions, fraying or friction damage.
- Never walk under a suspended forklift.
- Never use the overhead guard to hoist the truck.

11.7 Draw bar

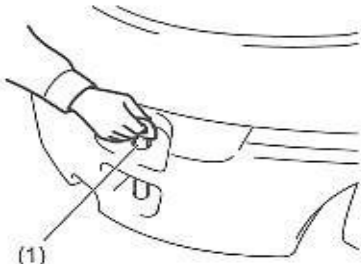

(1) Draw bar

⚠ CAUTION

The draw bar should not be used for towing the forklift or for towing another vehicle.

Observe the following cautions when lifting the forklift:

- Lifting points are located on the outer mast and the counterweight. The lifting points are indicated on the warning labels attached to the forklift.
- When required to attach a wire cable or strap to the top of the collapsed mast use an aid such as a ladder. Do not climb on any parts of the forklift e.g. counterweight and then overhead guard to gain access to lifting points on the mast as you may fall.

11.8 Overhead guard

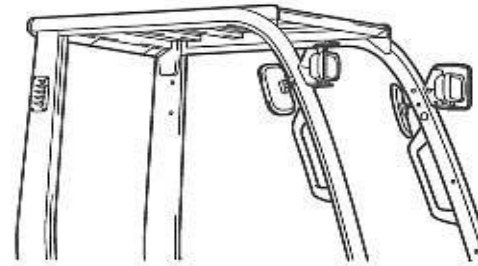

When properly maintained, the overhead guard will help protect the operator from falling objects.

11.9 Load backrest extension

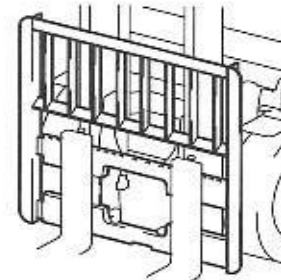

When properly maintained, the load backrest extension will help stabilize the load and prevent parts of a load from falling back into the operator's compartment.

11 BODY COMPONENTS

11.10 Mast

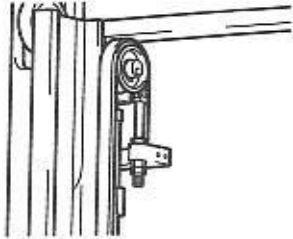

The mast uses special steel and precision bearings to make your Toyota lift truck reliable and economical.

The mast is mounted to the front of the truck. Hydraulic cylinders are used to tilt the mast forward and backward. Hydraulic cylinders and chains are used to raise the carriage and attachments.

⚠ WARNING

- The mast is designed for lifting loads not people. Do not use your forklift in place of an elevating work platform.
- Never place any part of your body in any part of the mast, the carriage or attachment.

11.11 Forks

Type A

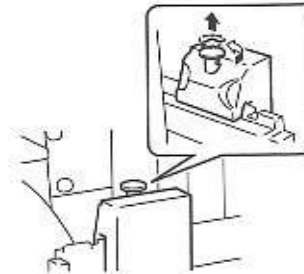

Type B

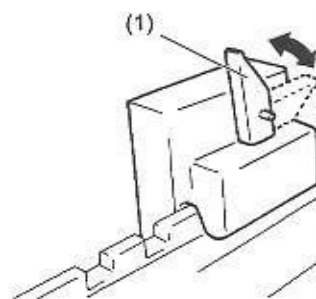

(1) Fork stopper

Adjust the forks in the position most appropriate for the load by unlocking the fork stopper.

1. Pull up and rotate the fork stoppers (Type A) or lift up the fork stoppers (Type B) to unlock.
2. Adjust the fork position.

⚠ WARNING

Forks are heavy. Caution is required when sliding a fork on the carriage as it may become difficult to slide even if force is applied to the fork when sliding it on the carriage.

NOTICE

When adjusting the forks, make sure that the weight of the load is centered on the truck.

3. After the adjustment, make sure to set the stopper to locked position to keep the forks in place.

⚠ WARNING

Make sure the forks are securely locked before carrying a load.



11.12 Lights

Head lights and front combination lights

Halogen head lights

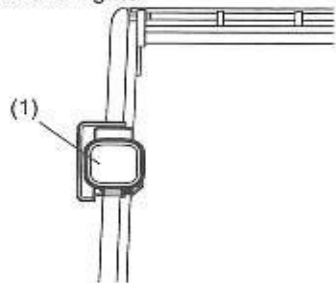

Head lights and front combination lights are fitted to right and left front side of the overhead guard. The lights can be operated by the light control switch.

Halogen head lights and front combination lights (Option)

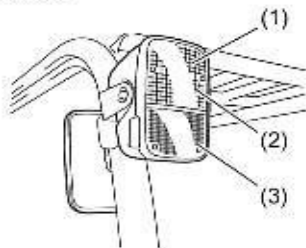

LED head lights and front combination lights (Option)

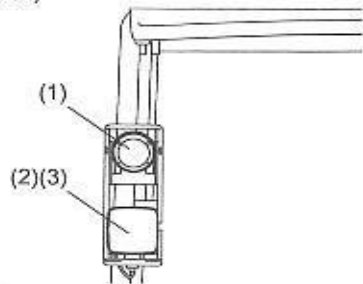

(1) Head lights
(2) Clearance lights
(3) Turn light

Rear combination lights

Rear combination lights

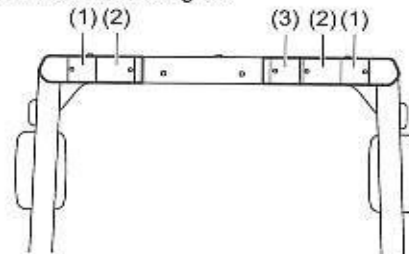

(1) Turn signal lights
(2) Stop/tail lights
(3) Back-up (reverse) light

Rear combination light is fitted to the rear of the overhead guard. Operate the turn signal lights by the turn signal switch.

11.13 Cabin (Option)

Standard Cabin

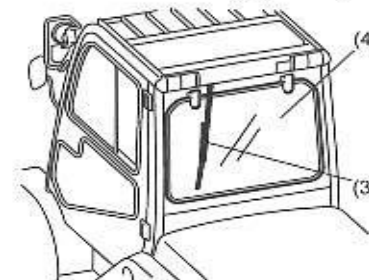
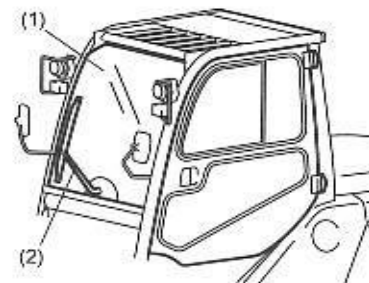



11 BODY COMPONENTS

FR Glass W/ Wiper

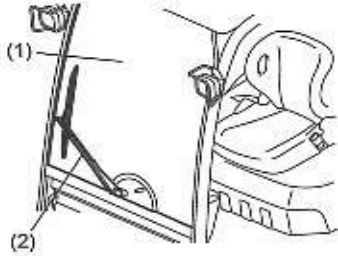

Half Cabin

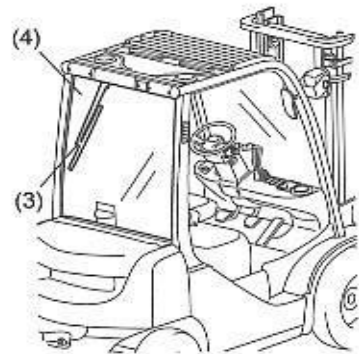
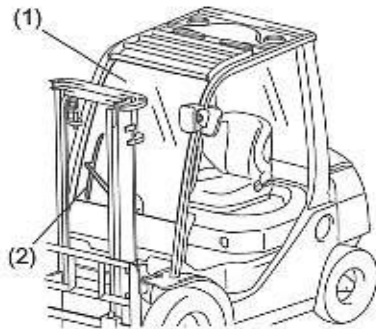

- (1) Front glass
- (2) Front wiper

- (3) Rear wiper
- (4) Rear glass

11.13.1 Doors

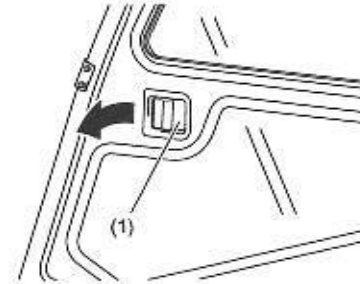

(1) Door handle

NOTICE

When opening the engine hood for cabin models, open the right and left doors of the cabin first.

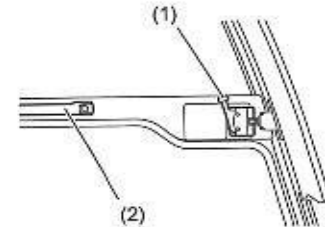

(1) Door inside lever
(2) Door pull handle

Opening/ closing doors (Outside the truck)

1. Grasp the door handle and pull toward you to release the lock and open the door.
2. When closing the door, press the door handle until the door lock catches.

Both doors can be locked by the key. (The door key is not the same as an ignition key switch.)

Opening/ closing doors (Inside the truck)

1. Shift the inside door lever to release the lock and open the door. Press the door pull handle to open the door.
2. When closing the door, pull the door pull handle until the door lock catches.

CAUTION

- When opening doors, be aware of pedestrians or other trucks.
- Always close the door by pulling the door pull handle. Before operating the truck, confirm that the doors are securely closed.



11.13.2 Rear window

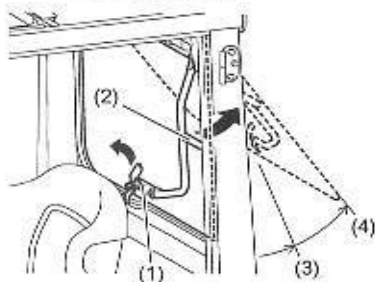

- (1) Lock lever
- (2) Assist lever
- (3) Ventilation mode
- (4) Maintenance mode

⚠ CAUTION

Do not travel with the rear window opened at the maintenance mode.

11.13.3 Wiper

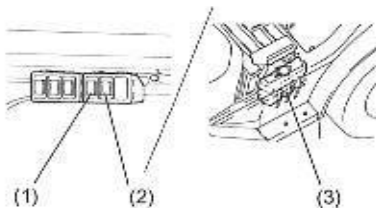

- (1) Front wiper switch
- (2) Rear wiper switch
- (3) Reservoir tank

NOTICE

To inspect or replenish washer fluid, use the reservoir tank located under the right step.

Opening/ closing the rear window

The rear window is a flip-up style window which can be set in two stages - to ventilation mode or maintenance mode.

1. Release the lock lever at the bottom of the window to open the window. Hold the assist lever and push the window back to open the window to ventilation mode.
2. Push the assist lever further back to extend the damper and the window will be opened to maintenance mode.
3. To close the rear window, hold the assist lever and pull on the rear window until it closes completely, then operate the bottom lock lever to lock position.

11.13.4 Interior lamp

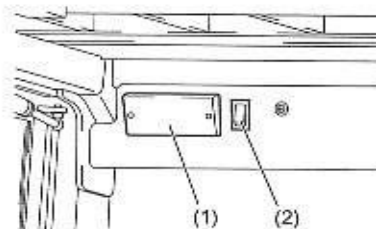

- (1) Room lamp
- (2) ON/OFF switch

The interior lamp is fitted to the right rear side of the cabin.

Use the switch to turn the light on and off.

11.13.5 Heater (Option)

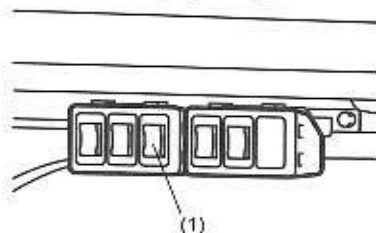

- (1) Heater switch

Using the heater

The heater is attached to the right side of the instrument panel.

The heater switch is located on the right-side of the overhead guard.

Press the heater switch to Hi or Low position to operate the heater in two air volumes. The air outlet can be opened or closed and the entry of debris and dust into the heater unit can be prevented.

NOTICE

- Use the heater after sufficiently warming up the engine.
- Running the heater fan for extended periods of time while the engine is stopped or while the engine is idling may cause over discharge of the battery and make engine starting impossible.
- Using the heater for extended periods of time will cause the air inside the cabin to become stale and the glass to fog, so take care to open windows and ventilate inside the cabin.

11 BODY COMPONENTS

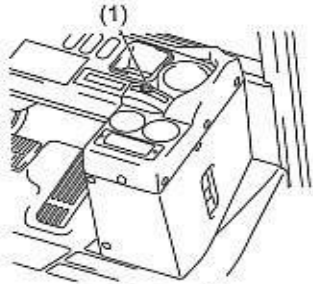

(1) Temperature adjustment lever

Defroster (Option)

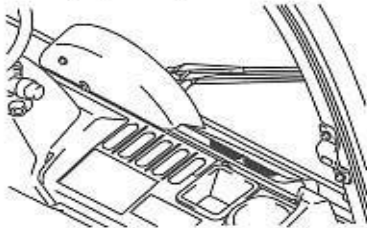

(1) Defroster

Temperature adjustment

This lever adjusts the temperature of the heater. Adjust the temperature to your preference.

Raising the temperature - Shift the lever to the left

Lowering the temperature - Shift the lever to the right.

The defroster is attached at the base of the front windshield. It will allow you to quickly defog the front windshield. Close the air outlet of the heater to turn on the defroster. Use the heater switches to switch on and off the defroster.

11.14 Premium Cabin (Option)

Overall view (Right-hand side)

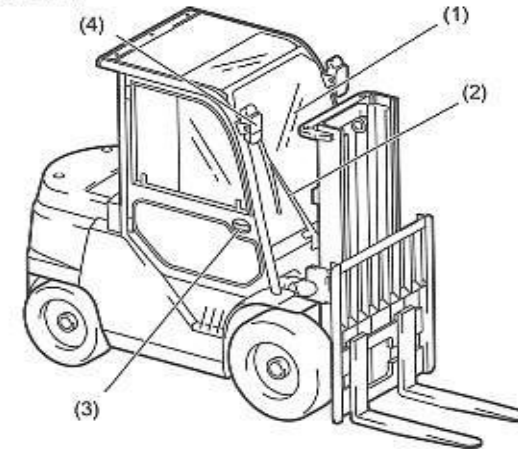

Overall view (Left-hand side)

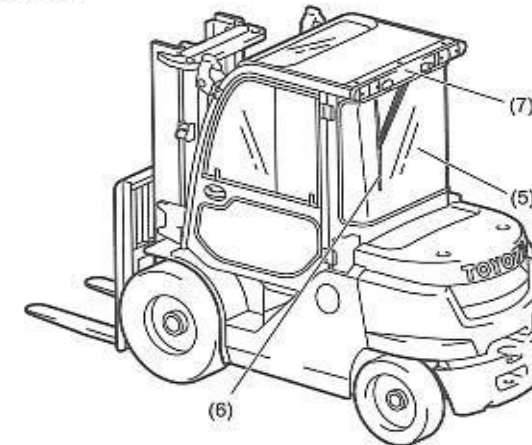

- (1) Front glass
- (2) Front wiper
- (3) Door handle
- (4) LED front working light

- (5) Rear glass
- (6) Rear wiper
- (7) LED rear working light



11.14.1 Side opening engine hood

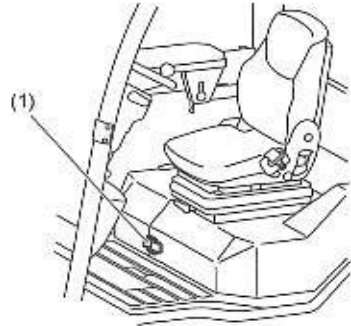

Opening

1. Fully open the right and left cabin doors.
2. Unlock the engine hood lock
3. Open the engine hood by sliding it to the right or left side of the truck.

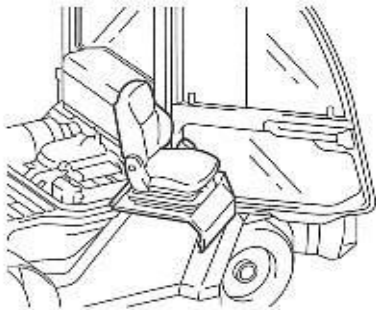

(1) Engine hood lock

Closing

1. Slowly close the engine hood.
2. Lock the engine hood lock securely.

⚠ WARNING

Working on the engine without locking of the hood may be hazardous.

11.14.2 Doors

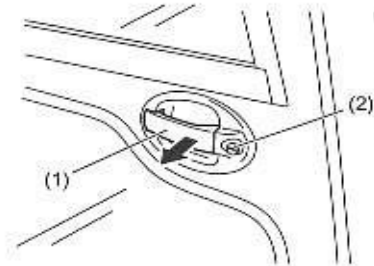

(1) Door handle
(2) Key hole

NOTICE

When opening the engine hood for cabin models, open the right and left doors of the cabin first.

The cabin doors can be opened in two stages - to full open (140°) or middle open (51°).

Opening/ closing doors (Outside the truck)

1. Grasp the door handle and pull toward you to release the lock and open the door.
2. When closing the door, press the door handle until the door lock catches.

Both doors can be locked by the key. (The door key is not the same as an ignition key switch.)

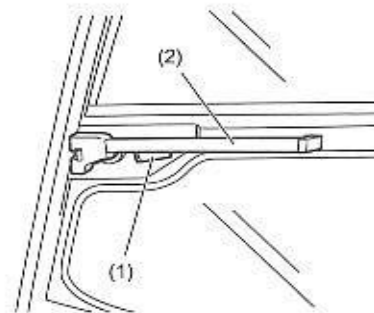

(1) Unlock lever
(2) Door pull handle

⚠ CAUTION

- When opening doors, be aware of pedestrians or other trucks.
- Always close the door by pulling the door pull handle. Before operating the truck, confirm that the doors are securely closed.

11 BODY COMPONENTS

11.14.3 Side door window

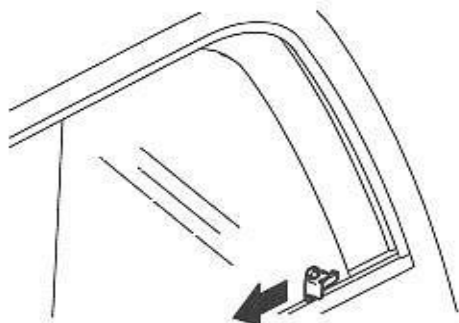

Opening/ Closing

The side windows can be opened in the right-left direction.

1. Grasping the knob at the center of the window will release the lock. Open the window to the left or right.
2. To close the side windows, use the knobs to slide the window to the right or left.

11.14.4 Roof window

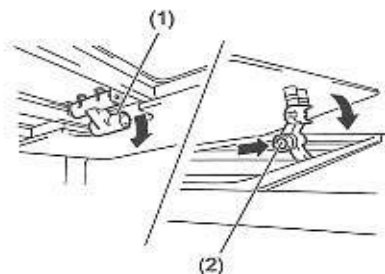

- (1) Opening/ closing lever
(2) Unlock button

The roof window can be opened up to 19°.

Opening/ Closing

1. To open the roof window, pull the lever and push up until the roof window is locked.
2. To close the roof window, hold the unlock button and pull down the lever. When the roof window is closed completely, return the lever to the original position.

11.14.5 Switch box

The switch box is located on the right-side of the overhead guard. The distribution of switch is as follows:

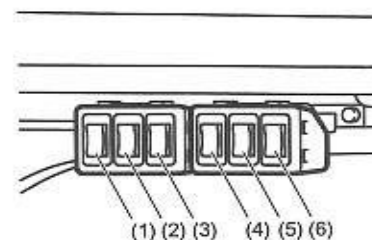

- | | |
|--|------------------------------------|
| (1) Fuel changeover switch (Gasoline-LPG models) | (4) Front wiper (Intermittent) |
| (2) Front and Rear working light switch | (5) Front wiper (Wiper and washer) |
| (3) Heater switch | (6) Rear wiper (Wiper and washer) |

11.14.6 Wiper

Operating the wiper

Press the upper part of the front or rear wiper switch to operate the wiper.

Press the upper part of the Front intermittent wiper switch to operate the front intermittent wiper.

Operating the washer

Press the lower part of the front wiper switch to operate the washer.

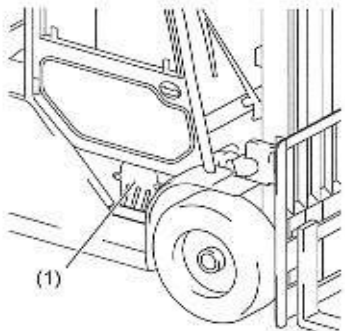

(1) Reservoir tank

NOTICE

To inspect or replenish washer fluid, use the reservoir tank located to the right of the operator's seat.

11.14.7 Front and Rear working light switch

The lighting condition of the front and rear working light is as follows:

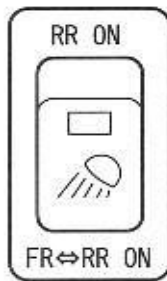

Working light switch position	Direction control lever position		
	Forward	Neutral	Reverse
Upper position	Rear working light ON		
Neutral position	OFF		
Lower position	Front working light ON		Rear working light ON

11.14.8 Interior lamp

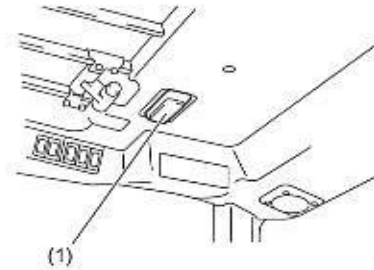

(1) Interior lamp

The interior lamp is fitted to the upper right side of the cabin.
Use the switch to turn the light on and off.

11.14.9 Reading light

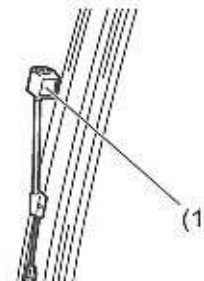

(1) Reading light

The reading light is fitted to the front pillar of the cabin.
The position of the light can be changed.

11.14.10 Curtain sun visor

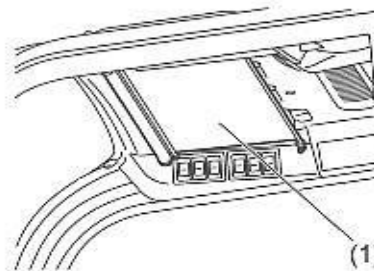

(1) Curtain sun visor

The curtain sun visor is fitted to the front windshield.

11 BODY COMPONENTS

11.14.11 12V power supply

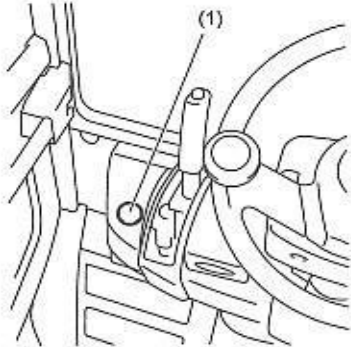

(1) 12V power supply

The 12 V power supply is fitted to left side of the instrumental panel.
It can be used for devices which have the maximum current of 4A or less.
12 V power supply is turned on/off by the key switch.

11.14.12 Coat Hunger

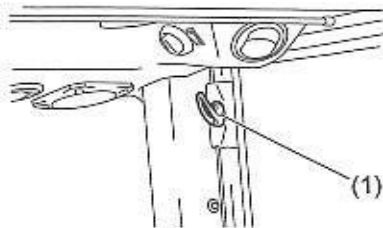

(1) Coat hunger

The coat hangers are fitted to the both right and left doors.

11.14.13 Audio

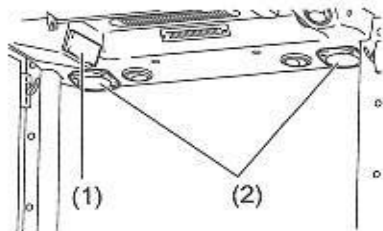

(1) Installation space for audio player
(2) Speaker

The installation space for the audio player, speaker and power supply are available for the use of audio.
Please ask the Toyota dealer for the audio equipment and its installation.

11.14.14 Heater and defroster

Right-hand side

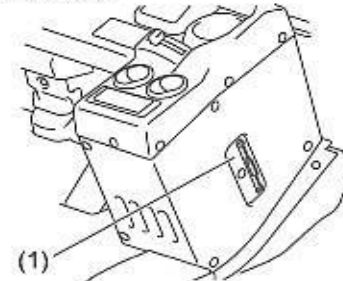

Left-hand side

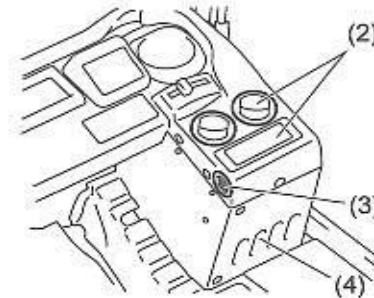

- (1) Filter
- (2) Duct for demisting
- (3) Duct for feet
- (4) Recycling filter

Using the heater

The heater is attached to the right side of the instrument panel.

Press the heater switch to Hi or Low position to operate the heater in two air volumes. The air outlet can be opened or closed and the entry of debris and dust into the heater unit can be prevented.

NOTICE

- Use the heater after sufficiently warming up the engine.
- Running the heater fan for extended periods of time while the engine is stopped or while the engine is idling may cause over discharge of the battery and make engine starting impossible.
- Using the heater for extended periods of time will cause the air inside the cabin to become stale and the glass to fog, so take care to open windows and ventilate inside the cabin.

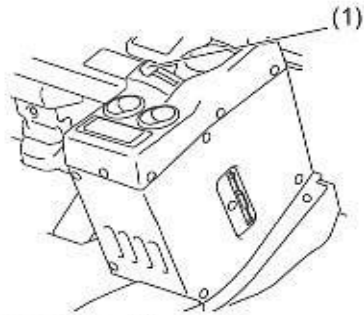

(1) Temperature adjustment lever

Temperature adjustment

This lever adjusts the temperature of the heater. Adjust the temperature to your preference.

Raising the temperature - Shift the lever to the left

Lowering the temperature - Shift the lever to the right.

Defroster

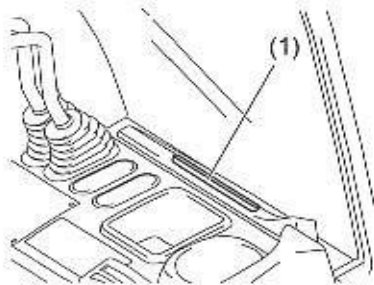

(1) Defroster

The defroster is attached at the base of the front windshield. It will allow you to quickly defog the front windshield.

Close the air outlet of the heater to turn on the defroster.

Use the heater switches to switch on and off the defroster.

**11.14.15 Air conditioning unit (Option)
(Diesel engine models)**

View from the outside

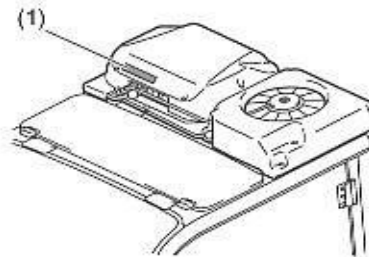

The air conditioning unit (Option) is fitted on the roof.

Use the A/C switches to switch on and off the air conditioner.

Use the air flow speed switch to adjust the air speed.

View from the inside

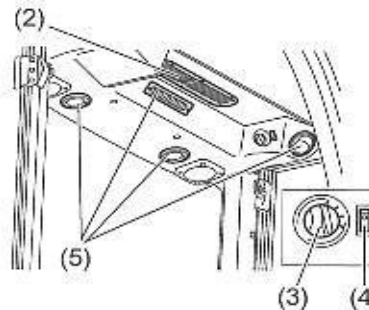

The air conditioning unit contains the following fluorinated greenhouse gas as shown by an information label.

Industrial designation : HFC-134a

Weight (actual) : 0.85 ± 0.01 kg

Weight (CO₂ equivalent) : 1201 - 1230 kg

GWP (Global Warming Potential) : 1430

- (1) Information label
- (2) Air suction duct
- (3) Air flow speed switch
- (4) A/C switch
- (5) Air flow duct

Information Label (in accordance with Regulation (EU) No 517/2014)

Air conditioning system containing the fluorinated greenhouse gas	HFC-134a GWP:1430 0.85±0.01kg ⇒ CO ₂ 1201~1230kg
---	---



12 INSTRUMENT

12 INSTRUMENT

12.1 Combination meter

Gauges and warning lamps on the combination meter are as follows:

Gasoline engine models

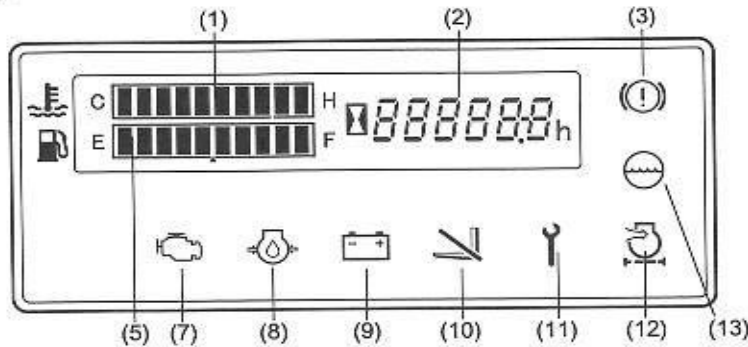

Diesel engine models

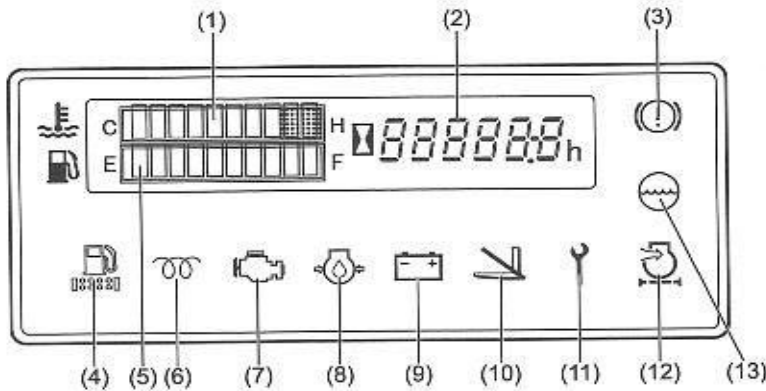

- (1) Water temperature gauge
- (2) Hour meter
- (3) Brake indicator (Option: OK monitor)
- (4) Sediment/fuel filter warning (Diesel engine models)
- (5) Fuel gauge
- (6) Glow indicator (Diesel engine models)
- (7) Malfunction indicator lamp

- (8) Engine oil pressure warning
- (9) Charging system warning
- (10) OPS indicator
- (11) Spanner indicator
- (12) Air cleaner warning (Option: OK monitor)
- (13) Cooling water level warning (Option: OK monitor)

12.1.1 Warning lamp check



(1) Key switch on

CAUTION

The glow indicator lamp illuminates for a second when the engine coolant temperature exceeds 50°C (122°F) (for diesel engine models).

12.1.2 Water temperature gauge

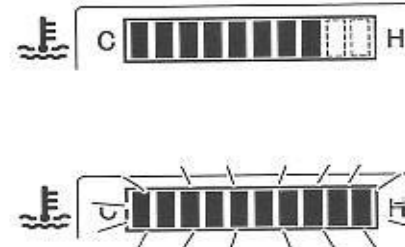

Indicates the temperature of the engine coolant.

- This gauge functions with the key switch on and displays the cooling water temperature from left to right in a 10-stage gradation scale (In normal condition, the final two stages on the far right do not illuminate).
- The operator will be notified when the water temperature is abnormally high as the entire gauge starts blinking. At that time, engine output will be limited to prevent engine overheating.
- Temporary overheating may be caused by coolant leakage, low engine coolant level, loosen fan belt, or other problem in the cooling system. Ask the Toyota dealer for an inspection.



⚠ CAUTION

Once the entire gauge blinks, discontinue the operation in progress and park the truck in a safe location, apply the parking brake and remove the key. Then, ask the Toyota dealer for an inspection.

12.1.3 Hour meter



The hour meter operates when the key switch is turned on.

It indicates the total number of truck operating hours.

The digit on the far right displays in 1/10 of an hour.

When the truck operating hour reaches 62500 hours, the meter will display "FULL".

Use this meter for the timing of periodic maintenance and recording the operating hours.

When an abnormality occurs to the truck (spanner indicator lamp blinks) the error code and hour meter will be alternately displayed.

⚠ CAUTION

- Should an error code be displayed, stop the operation in progress and park the truck in a safe location, apply the parking brake and remove the key. Then, ask the Toyota dealer for an inspection.
- When the timing belt is used over 4000 hours, the hour meter displays "bELT" for 10 seconds and the spanner indicator lamp illuminates after the key switch is turned on. (Diesel engine models) Once "bELT" is displayed, have the timing belt replaced by the Toyota dealer immediately. Failure to do so could cause serious damage to the engine. Refer to Timing belt caution function section of this chapter for details.

12.1.4 Sedimenter/ fuel filter warning

(Diesel engine models)

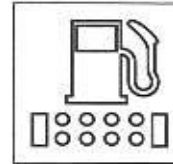

The sedimenter is a device for separating water from the fuel.

The fuel filter is a device for separating foreign material from the fuel.

- The sedimenter/ fuel filter warning lamp comes on to indicate that water in the sedimenter exceeds the predetermined level while the engine is running or the negative pressure of the fuel filter reaches the predetermined pressure while the engine is running.
- If normal, the warning lamp comes on when the key switch is turned on and goes off when the engine starts.
- If the warning lamp comes on while the engine is running, drain the water from the sedimenter immediately. (See the OPERATOR MAINTENANCE chapter of this manual for the draining method.)
- If the warning lamp continues to illuminate while the engine is running, ask the Toyota dealer for an inspection.

⚠ CAUTION

Continued operation with warning on may cause damage to the supply pump.

12.1.5 Fuel gauge

(Excluding LPG models)



Indicates the amount of remaining fuel in the fuel tank in terms of a 10-stage gradation scale.

The operator will be warned that the remaining fuel level is low when the two stages at far left start blinking.

It takes some time for the indicator to stabilize after refueling and the key switch is turned on.

NOTICE

- If the operating area is not level, the correct level may not be indicated. Always check the fuel level on a level surface.
- When the gauge begins blinking, refuel as soon as possible.
- In case of the diesel engine, when the fuel runs out, it will become necessary to bleed air from the fuel supply system. Be sure to refuel before it runs out.

12 INSTRUMENT

12.1.6 Glow indicator

(Diesel engine models)

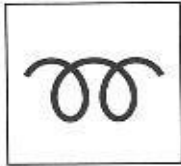

Indicates heating of the glow plugs.
The indicator lamp comes on and glow plug heating begins when the key switch is turned on. The lamp goes off automatically when glow plug heating is completed.
The engine will start easily once the glow plugs are heated.

⚠ CAUTION

If the glow indicator lamp does not go off, the glow plugs may be defective. Ask the Toyota dealer for an inspection.

NOTICE

The glow indicator lamp illuminates for a second when the engine coolant temperature exceeds 50°C (122°F).

12.1.7 Malfunction indicator lamp

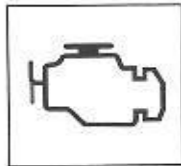

- When an error occurs to the engine control system, the lamp illuminates to inform the operator.
- When the condition is normal, the lamp illuminates when the key switch is turned on and goes off when the engine starts.

⚠ CAUTION

Once the malfunction indicator lamp has come on during operation, stop the operation in progress and park the truck in a safe location, apply the parking brake and remove the key. Then, ask the Toyota dealer for an inspection.

12.1.8 Engine oil pressure warning

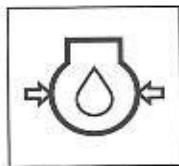

- The engine oil pressure warning lamp comes on to indicate low engine oil pressure while the engine is running.
- If normal, the warning lamp comes on when the key switch is turned on and goes off when the engine starts.

⚠ CAUTION

If the warning lamp comes on while the engine is running, either the engine oil is low or the lubrication system is faulty. Stop the operation in progress and park the truck in a safe location, apply the parking brake and remove the key. Then, ask the Toyota dealer for an inspection.

NOTICE

The engine oil pressure warning lamp does not indicate the oil level. Check the oil level with the oil level gauge before starting work.

12.1.9 Charging system warning

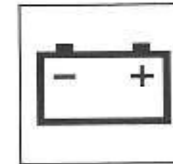

- The charging system warning lamp comes on to indicate a problem in the charging system while the engine is running.
- If normal, the warning lamp comes on when the key switch is turned on and goes off when the engine starts.

⚠ CAUTION

- If the warning lamp comes on while the engine is running, stop the operation in progress and park the truck in a safe location, apply the parking brake and remove the key. After the engine has cooled down, inspect the engine ancillary drive belt for cuts or looseness, adjust it, and restart the engine.
- If lamp does not go off, the electrical system may be faulty. Ask the Toyota dealer for an inspection.

12.1.10 OPS indicator

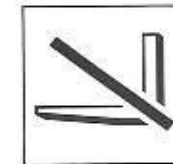

- If the operator leaves the seat while the truck is in operation, the OPS indicator lamp illuminates to inform the operator that the system is going to be activated.
- If this lamp illuminates, and OPS is activated, return the direction control lever, lift and tilt levers and accelerator pedal to their neutral positions and return to the seat. For details of OPS function, refer to OPS FUNCTION section of this manual.

⚠ CAUTION

In any of the following cases, a malfunction may have occurred to the OPS. Park the truck in a safe location, apply the parking brake, remove the key and ask the Toyota dealer for an inspection.

- The OPS indicator lamp does not illuminate when the operator is not seated in the normal operating position.
- The OPS indicator lamp does not go off when the operator is in the normal operating position.



12.1.11 Spanner indicator



The spanner indicator lamp illuminates or blinks when an error is found in the engine control system or SAS/OPS and an error code will be displayed in the hour meter display area.

⚠ CAUTION

- In any of the following cases, a malfunction may have occurred to the system. Park the truck in a safe location, apply the parking brake, remove the key and ask the Toyota dealer for an inspection.
 - The indicator lamp does not illuminate when the key switch is turned on.
 - The indicator lamp illuminates or blinks during traveling (operation).
- Continuing to use the truck while the spanner indicator lamp is illuminated or blinking may lead to a breakdown. When the indicator lamp illuminates or blinks, stop the operation, park the truck in a safe location, apply the parking brake, remove the key and ask the Toyota dealer for an inspection. (For diesel engine models, the spanner indicator lamp may stay illuminated during engine warm-up after a cold engine start. This does not indicate a malfunction.)
- If the operator remains seated for a long period with the key switch turned off, the next time the key switch is turned on, the spanner indicator lamp may start blinking. If this occurs, turn the key switch off, return to the normal operating position and then turn the key switch back on. The spanner indicator lamp will then go off.

12.1.12 OK monitor (Option)

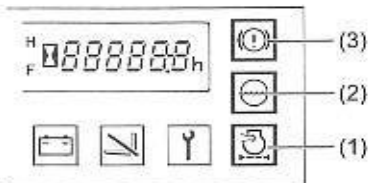

This function monitors the air cleaner element clogging status, engine coolant level, brake fluid level, and parking brake status. Warning lamps come on to indicate a problem.

- (1) Air cleaner warning
- (2) Cooling water level warning
- (3) Brake indicator

⚠ CAUTION

Always perform pre-operation checks, even if the OK monitor warning lamps are not on. Do not rely on the OK monitor.

12.1.12.1 Air cleaner warning



- This warning lamp comes on when the air cleaner element gets clogged while the engine is running.
- If normal, the warning lamp comes on when the key switch is turned on and goes off when the engine starts.
- If the warning lamp comes on while the engine is running, stop the operation and park the truck in a safe location, apply the parking brake. Stop the engine, remove the key and clean the element and dust cup. Refer to WEEKLY MAINTENANCE section of this manual for the cleaning method.

12.1.12.2 Coolant level warning

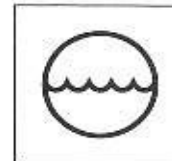

- This warning lamp comes on when the engine coolant level in the radiator reservoir tank is too low.
- If normal, the warning lamp comes on when the key switch is turned on and goes off when the engine starts.
- When the warning lamp comes on, add engine coolant to the upper level in the reservoir tank. Refer to PRE-OPERATION CHECK section of this manual for the method of adding coolant.

NOTICE

Even if the cooling water level warning lamp is not on, always inspect the coolant level before starting operations.

12 INSTRUMENT

12.1.12.3 Brake indicator



- The brake indicator lamp comes on when the parking brake is applied. (It goes off when the parking brake is released.)

CAUTION

- Before starting the truck, always release the parking brake lever and check that the lamp goes off.
- If the warning lamp remains on even after the parking brake is released, ask the Toyota dealer for an inspection.

12.1.13 Timing belt caution function

(Diesel engine models)

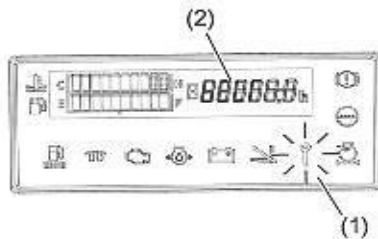

- (1) Spanner indicator
- (2) Hour meter

When the engine timing belt is used over 4000 hours, the combination meter indicates that the timing belt needs to be replaced by the following behavior:

- **Spanner indicator** - Illuminates continuously after the key switch is turned on.
- **Hour meter** - Displays "bELT" for 10 seconds after the key switch is turned on.

Should the above conditions occur, park the truck in a safe location, apply the parking brake and contact the Toyota dealer immediately.

CAUTION

- Once the timing belt caution function is on, have the timing belt replaced by the Toyota dealer immediately. Failure to do so could cause serious damage to the engine.

NOTICE

The diesel engine timing belt needs to be replaced after every 4000 hours of use. It also needs to be replaced when the SAS/OPS controller or the combination meter is replaced.

12.2 Multi-function display (Option)

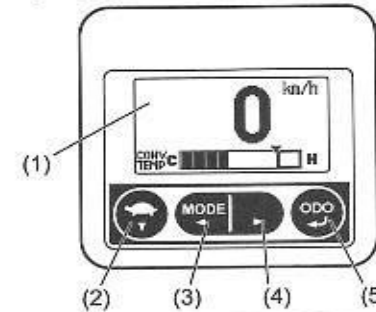

No.	Switch name	Function
(1)		Multiple screen display area
(2)	Switch (a)	Low-speed setting switch/ Down switch
(3)	Switch (b)	Mode select switch/ Left switch
(4)	Switch (c)	Right switch
(5)	Switch (d)	Meter mode select switch/ Enter switch

NOTICE

- Always operate the switch panel when the truck is stopped.
- Always press switches with your finger tips. If a sharp pointed tool is used, the switch may be damaged.

12.2.1 Start screen

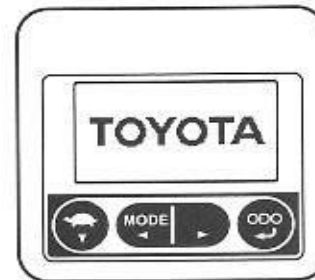

The start screen is displayed for 1 second after the key switch is turned on.

12.2.2 Meter screen

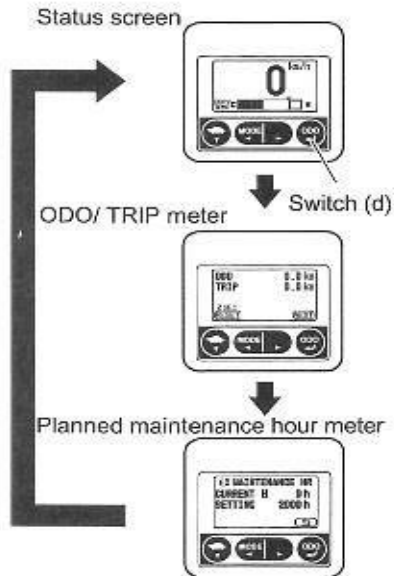

Press switch (d) to change the status screen to ODO/ TRIP meter and Planned maintenance hour meter screens.

12.2.2.1 Status screen

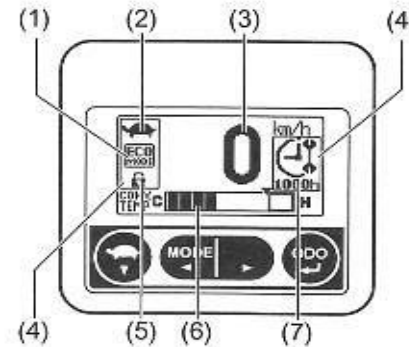

The status screen is displayed after the start screen.

- (1) Eco-mode indicator
- (2) Low-speed setting indicator
- (3) Digital speedometer
- (4) Function activation indicator
- (5) Menu lock indicator
- (6) Torque converter oil temperature indicator
- (7) Maintenance indicator

12.2.2.2 Speedometer/ Torque converter oil temperature indicator

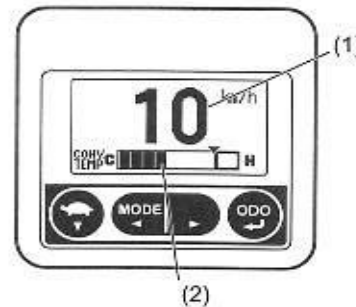

Truck speed is digitally indicated in km/h in the middle of the screen.
At the bottom of the screen, torque converter oil temperature is indicated in 10 levels.

- (1) Speedometer
- (2) Torque converter oil temperature indicator



12 INSTRUMENT

12.2.2.3 ODO/TRIP meter

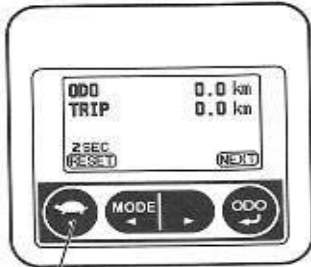

(1)

(1) Switch (a)

NOTICE

Press switch (a) for more than 2 seconds to reset the TRIP total travel distance.

ODO - Displays the total travel distance
TRIP - Displays the total travel distance after resetting

12.2.2.4 Planned maintenance hour meter

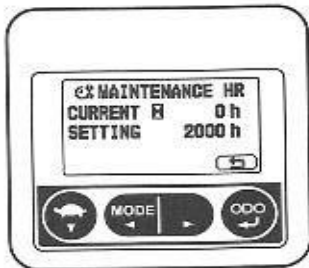

Displays the preset service interval time and the current elapsed time of the planned maintenance hour meter.

CURRENT - Displays the current time
SETTING - Displays the preset service interval time

The preset interval time can be set between 10 to 2400 hour. 10 to 200 hour setting can be set in 10 hour intervals, and 200 to 2400 hour setting can be set in 50 hour intervals.

The hour meter integrates the elapsed time while the key switch is turned on. It also continues to include the elapsed time even if it exceeds the preset service interval time.

Use this meter for the timing of periodic maintenance and recording the operating hours.

NOTICE

To change the time setting, ask a supervisor or the Toyota dealer.

12.2.2.5 Maintenance indicator

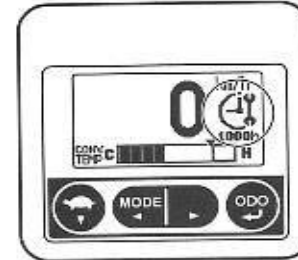

The maintenance indicator will be displayed when the maintenance hour meter exceeds the preset service interval time, and a warning sound will sound for 5 seconds each time the key switch is turned on.

NOTICE

To change the maintenance time setting, ask a supervisor or the Toyota dealer.

12.2.3 Load meter

(Only with Multi-function Display DX)



Returning the lift lever to the neutral from the lifting position will display the weight of the load being handled on the status screen. The weight of the load is displayed in an unit of 0.01 ton.

The recommended operating condition is as follows:

- Traveling and load handling operation is stopped
- The mast is set in a vertical position
- The load height is approx. 500 mm above the ground

CAUTION

This function should be used as reference when conducting load handling operations, and not used in business dealings or as proof of actual weight.



NOTICE

- Use this function when traveling and load handling operations are stopped.
- If the load is less than 100kg, the meter will indicate 0.00t.
- The load weight is displayed for about 5 seconds each time the lift lever is returned to neutral position. The load weight is not displayed when the traveling speed is detected. To change the display time, ask the Toyota dealer.
- The load meter measures the load by reading the lift cylinder pressure, so this function should not be used to check for overload when the load weight is near maximum capacity.
- When the load is lifted to a maximum lift height, a higher weight value will be displayed due to a residual pressure generated by the relief stop.
- If zero point of the load meter is slightly deviated toward the minus side, the display will indicate -0.00t. Ask the administrator for zero point adjustment.

Load meter error display

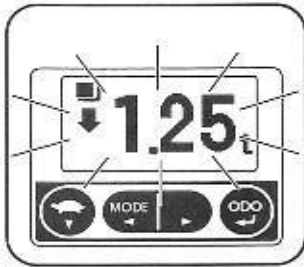

The accuracy of the load meter drops while the load is lifted to a high position because of the influence of the mast deflection and friction. In that case, an arrow will appear at left of the screen and the measured weight indication will blink to notify the operator that the reading is inaccurate.

To measure the load, always set the load to a height of approx. 500mm above the ground and set the mast vertically.

Load meter sensor error display

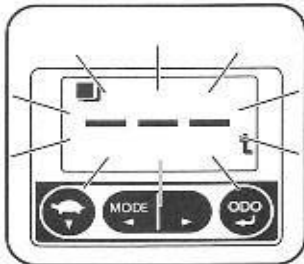

If an error has been detected in the load meter sensor, the display will blink to notify the operator of an error.

NOTICE

When the load meter display blinks to indicate an error, ask the Toyota dealer for an inspection.

12.2.4 Low-speed setting indicator

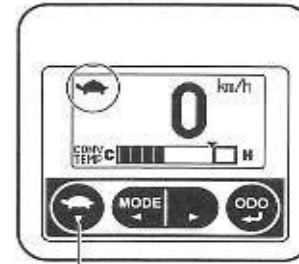

(1)

(1) Switch (a)

When low-speed settings have been set, the turtle mark is displayed.

Each time switch (a) is pressed, the turtle indicator will illuminate and go off alternatively. When the indicator is displayed, the low-speed setting control is active.

The low-speed setting value can be set on the Operator setting menu screen. Refer to the Operator setting menu screen section of this manual for details.

12.2.5 Eco-mode indicator

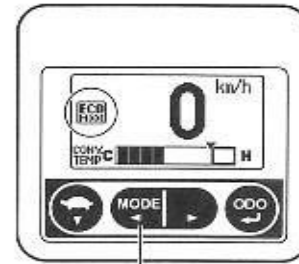

(1)

(1) Switch (b)

When the eco-mode indicator is displayed, the eco-mode function is active.

Press switch (b) to turn on/off the eco-mode. Eco-mode cannot be turned on/off when the menu lock setting is active.

12.2.6 Menu lock indicator

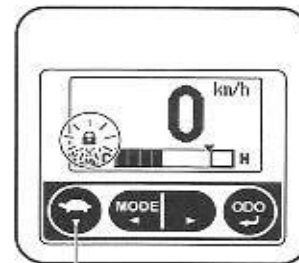

(1)

(1) Switch (a)

The menu lock indicator is displayed when the menu lock setting is active.

When the menu lock setting is active, the Operator setting menu screen cannot be operated. If switch (a) is pressed for 2 seconds or more on the status screen, the indicator will blink to inform that the operation is invalid.



12 INSTRUMENT

12.2.7 Spanner indicator

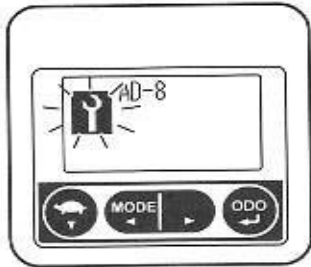

The spanner indicator and the error code will be displayed when an error is found and a warning sound will warn the operator.

NOTICE

- The error code displayed on the screen varies depending on the content of the error. There are also cases when no error code is displayed.
- When the spanner indicator is displayed, ask the Toyota dealer for an inspection.

12.2.8 Parking brake on warning

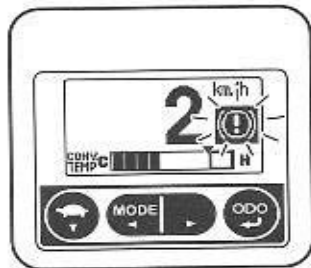

The parking brake on warning indicator will blink and the warning sound will warn the operator if the truck travels without releasing the parking brake.

⚠ CAUTION

- If the truck is operated without releasing the parking brake, the brake will lose effectiveness. Ask the Toyota dealer for an inspection.
- If the indicator does not go off even when the parking brake is released, stop the operation in progress and park the truck in a safe location, apply parking brake and remove the key. Then, ask the Toyota dealer for an inspection.

12.2.9 Torque converter oil temperature overheating warning

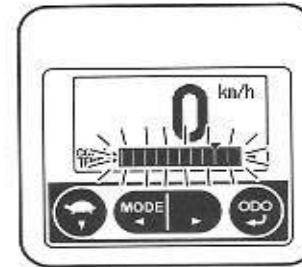

When the torque converter oil temperature reaches level 9 on the indicator [approx. 120 °C (248 °F) or over], the indicator will blink and a warning sound will sound for 5 seconds to notify the operator.

When the torque converter oil temperature reaches level 10 [approx. 135 °C (275 °F) or over], the entire indicator will blink to notify the operator. If the accelerator pedal is pressed, the warning sound will notify the operator.

If the key switch is turned on when the torque converter oil temperature is over level 9, the warning sound will sound for 5 seconds to notify the operator.

NOTICE

When the indicator blinks, park the truck in a safe location, apply the parking brake, open the engine hood with the engine idling, and allow the torque converter oil to cool.

12.2.10 Over-speed alarm

(Only with Multi-function Display DX)

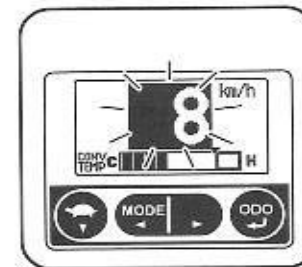

When the traveling speed exceeds the preset speed, the speedometer will blink and a warning sound will notify the operator.

The over-speed alarm setting value can be set on the Operator setting menu screen. Refer to the Operator setting menu screen section of this manual for details.

NOTICE

Unlike the low-speed setting, this function does not limit the traveling speed. Pay attention to the speed when operating the truck.



12.2.11 Operator setting menu screen

Press switch (a) on the status screen for more than 2 seconds to display the Operator setting menu screen.

1. Press switch (a) to select the menu and press switch (d) to enter the setting screen.
2. If you press switch (d) when selecting END menu, you can return to the status screen.

NOTICE

When the menu lock is active, the Operator setting menu cannot be operated.

Models with Multi-function Display

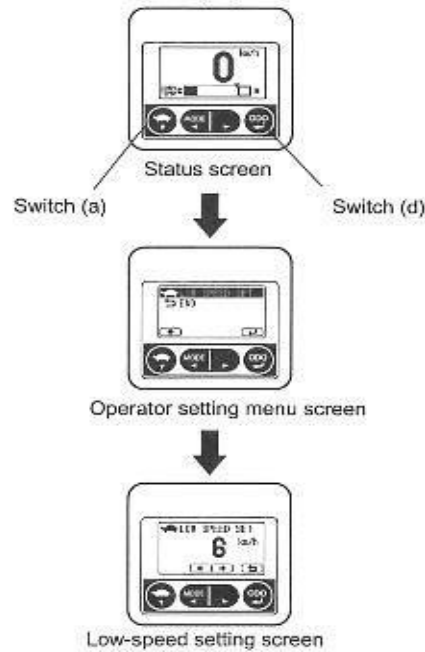

Models with Multi-function Display DX

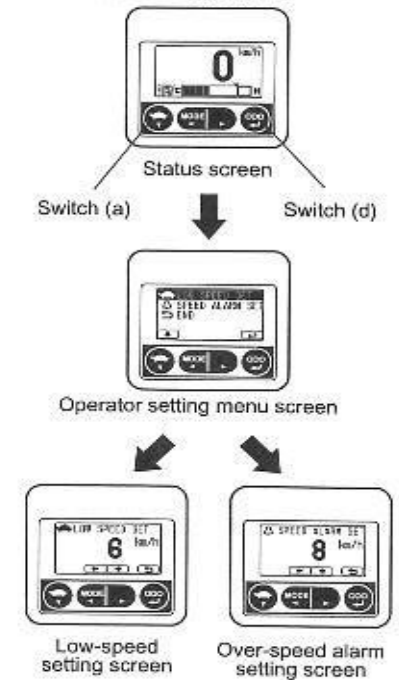

12 INSTRUMENT

12.2.11.1 Low-speed setting screen

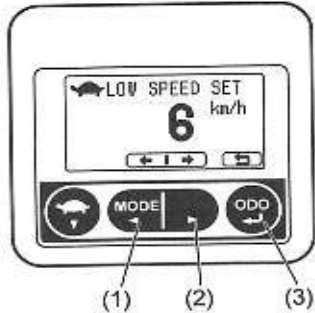

- (1) Switch (b)
- (2) Switch (c)
- (3) Switch (d)

The low-speed setting value can be changed on this screen.

Switch (b) - Setting the traveling speed slow
Switch (c) - Setting the traveling speed fast
Switch (d) - Returning to the Operator setting menu screen

The setting value is adjustable from 5km/h to 32km/h in increments of 1 km/h.

If the speed is set over 32km/h, the low-speed setting is disabled. In this case, "OFF" is displayed.

12.2.11.2 Over-speed alarm setting screen

(Models with Multi-function Display DX)

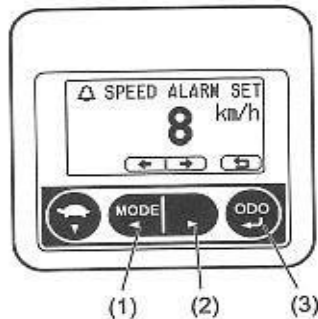

- (1) Switch (b)
- (2) Switch (c)
- (3) Switch (d)

The over-speed alarm setting value can be changed on this screen

Switch (b) - Setting the traveling speed slow
Switch (c) - Setting the traveling speed fast
Switch (d) - Returning to the Operator setting menu screen

The setting value is adjustable from 5km/h to 32km/h in increments of 1 km/h.

If speed is set over 32km/h, the over-speed alarm function is disabled. In this case, "OFF" is displayed.

12.2.12 Administrator setting menu

12.2.12.1 Administrator Menu List

Setting menu	Setting screen
Traveling setting menu	Traveling speed setting for low speed*
	Traveling speed setting for maximum speed control
	Traveling speed setting for over speed alarm*
Truck control setting menu	Load meter point 0 setting
	Maintenance hour meter setting
	Engine auto stop time setting
	Secondary manager password setting
	Menu lock setting

*: General operators can be used when the menu lock setting is off.



12.2.12.2 Password Entry Procedure

NOTICE

Always operate switches on the display with a fingertip. If a sharp pointed tool is used, the switch may be damaged.

If an operation error occurs during entry operation, turn the key switch OFF and start over again.

Entry procedure of administrator password

Step	Display	Operation	Vehicle response
1		Press switch (2) and switch (4) at the same time for more than 2 seconds.	When pressing the switches, a short beep sounds, and after 2 seconds another short beep sounds.
2		Press switch (3) within 10 seconds.	A short beep sounds.
3		Press switch (3) within 10 seconds.	A short beep sounds.
4		Within 10 seconds, press switch (2) and switch (4) at the same time for more than 2 seconds.	When pressing the switches, a short beep sounds, and after 2 seconds repeated short beeps sound.
5		<ul style="list-style-type: none"> When the second password has been set: Password screen is displayed. Enter the password. Other: Skip this screen. 	
6		Administrator menu screen is displayed automatically.	



12 INSTRUMENT

12.2.12.3 Administrator setting menu screen

1. Press switch (a) to select the menu and press switch (d) to enter the setting screen.
2. If you press switch (d) when selecting END menu, you can return to the status screen.

▪ *Mmodels with Multi-function Display*

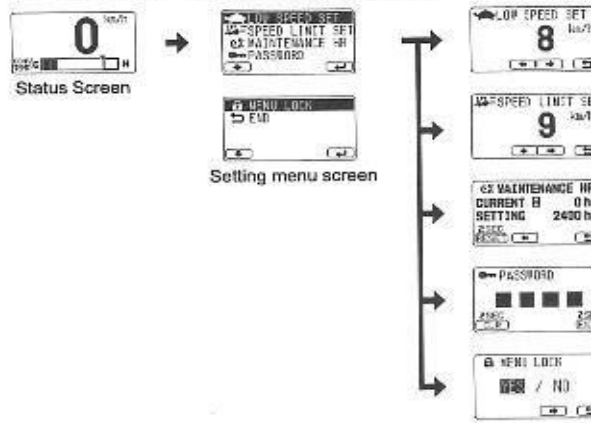

▪ *Mmodels with Multi-function Display DX*

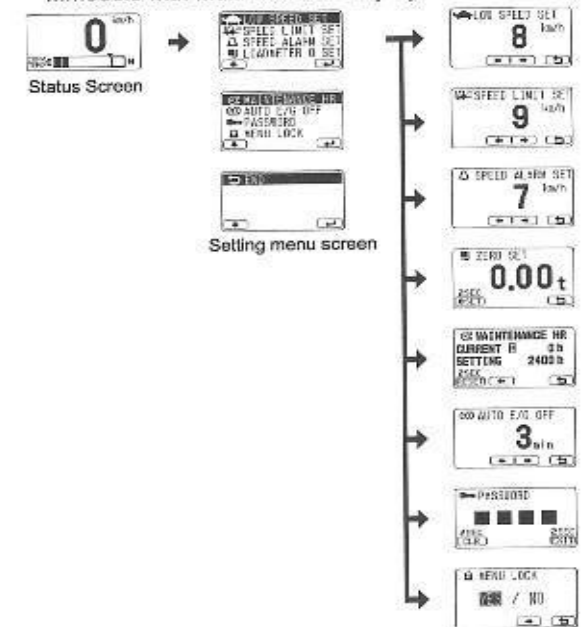



Low speed setting screen

(1FS or 1KD engine equipped models)

You can change the speed limit value of the low speed setting function.



Switch(b):Decrease traveling speed.

Switch(c):Increase traveling speed.

Switch(d):To the menu screen

The value can be set in a range between 5 to 32 km/h in 1 km/h (3 to 20 mph/h in 1 mph/h) steps.

If set the speed to more than 32 km/h (20 mph), the low speed function is disabled. In that case "OFF" is displayed.

Travel speed limiter setting screen

(1FS or 1KD engine equipped models)

You can change the speed limit value of the travel speed limiter function.



Switch (b): Decrease traveling speed.

Switch (c): Increase traveling speed.

Switch (d): To the menu screen

The value can be set in a range between 5 to 32 km/h in 1 km/h (3 to 20 mph in 1mph/h) steps.

When an operator tries to set the value to more than 32 km/h (20 mph) , the maximum speed limiter function will be disabled. In that case "OFF" is displayed.

Over speed alarm setting screen

(Models with multi-function display DX)

You can change the speed value at which the over speed alarm function should trip.



Switch(b):Decrease traveling speed.

Switch(c):Increase traveling speed.

Switch(d):To the menu screen.

The value can be set in a range between 5 to 32 km/h in 1 km/h (3 to 20 mph/h in 1mph/h) steps.

When an operator tries to set the value to more than 32 km/h (20 mph/h), the over speed alarm setting will be disabled. In that case "OFF" is displayed.



12 INSTRUMENT

Load meter point 0 adjustment screen

(Models with Multi-function display DX)

Adjust point 0 of the load meter.

[V mast]

Low lift height(ZERO SET):

1. Stops traveling or load handling, makes the mast almost vertical, and lifts the fork up to approximately 500 mm from the ground.
2. Pressing switch (a) for two seconds or more will reset the display value to 0.00 and display "OK".
3. Press switch (d) to return to the menu screen.



[FV mast, FSV mast]

Low lift height(ZERO SET 1):

1. Stops traveling or load handling, makes the mast almost vertical, and lifts the fork up to approximately 500 mm from the ground.
2. Pressing switch (a) for two seconds or more will reset the display value to 0.00 and display "OK".
3. Press switch (d) to return to the next screen.

High lift height(ZERO SET 2):

1. Stops traveling or load handling, makes the mast almost vertical, and lifts the rear cylinder up to approximately 100mm from the ground.
2. Pressing switch (a) for two seconds or more will reset the display value to 0.00 and display "OK".
3. Press switch (d) to return to the menu screen.



Maintenance hour meter setting screen

Time for maintenance hour meter is set. Possible values are 10 to 2400 hours, where 10 to 200 hours are available in steps of 10 hours and 200 to 2400 hours in steps of 50 hours.



Switch (b): Decrease the set value.

Switch (c): Increase the set value.

Switch (d): To the menu screen

Pressing switch (a) for two seconds or more will reset the current value to 0. (The set value is maintained even after this reset procedure.)

When the set time is 10 hours and switch (b) is pressed to decrease the set time, the maintenance hour meter is set to OFF.

When OFF, the elapsed time is retained, but maintenance indicator and buzzer notifications will not be provided anymore.

Auto engine stop time setting screen

(1FS or 1KD engine equipped models with Multi-function display DX)

You can change the interval at which the auto engine stop function is operated.



Switch (b): Decrease the set value.

Switch (c): Increase the set value.

Switch (d): To the menu screen

The time can be set to a value in a range between 10 seconds to 1minute in 10 seconds steps, 1 to 30 minutes in 1 minute steps.

Select OFF after 30 minutes to disable the auto engine stop function. In that case "OFF" is displayed.



Secondary manager password setting screen

In this screen, you can register or clear a password.

Password registration

A manager can register a secondary password.

Enter a password using switches (a) to (d), then press and hold switch (a) for two seconds to register the password.

Press switch (d) for two seconds to return to the menu screen.

If the switch (d) is pressed for two seconds before setting password, the screen returns to the menu, and the password will not be registered.

A manager must manage his/her secondary password so he/she would not forget it.

If you forget your password, ask the Toyota dealer to delete the password.

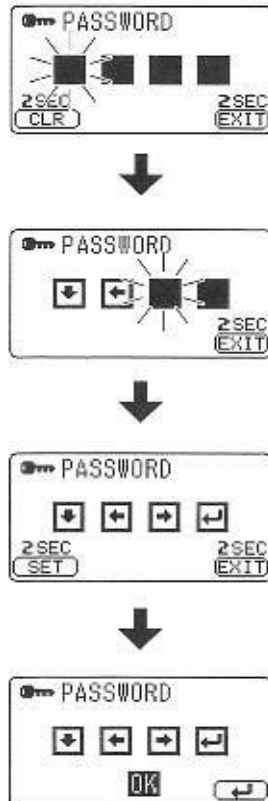

Clear password

In the secondary manager password setting screen, press switch (a) for two seconds or more to clear the password.

Press switch (d) for two seconds to return to the menu screen.

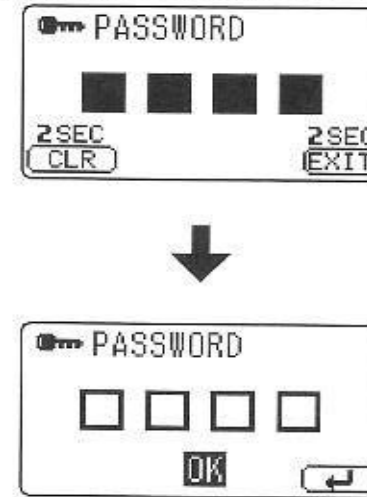



12 INSTRUMENT

Menu lock setting screen

This screen enables the operator to limit a change of a set value.

When set to YES, the following limitations will be applied.

- The operator setting menu screen is hidden.
- Eco-mode switching is disabled.

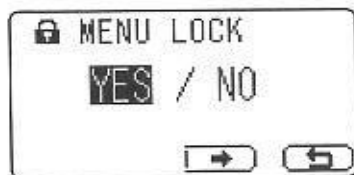

Switch (b): Select YES.

Switch (c): Select NO.

Switch (d): To the menu screen

The unlock conditions depend on the menu lock specification available as an option set item.

When the menu lock specification setting is set to A

The menu unlock setting (NO) is in effect until the key is turned OFF. (The setting is set to YES at key OFF.)

When the menu lock specification setting is set to B

The menu unlock setting (NO) is in effect until a user changes the setting to YES again in the setting screen.

12.3 TELEMATICS (OPTION)

Only operators who have registered PINs (Personal Identification Number) can activate the truck with this feature. This can contribute to avoidance of irregular uses by uncertified persons.

PINs consist of 5 figures. If leading digits are "0", they can be skipped when entering the code on the keypad (Example: When the PIN is "00123", you can enter "123").

Except Deluxe Cabin

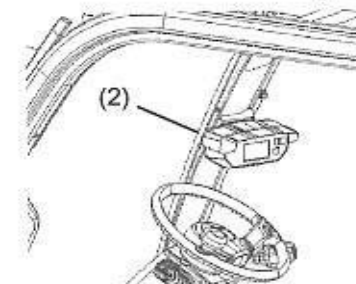
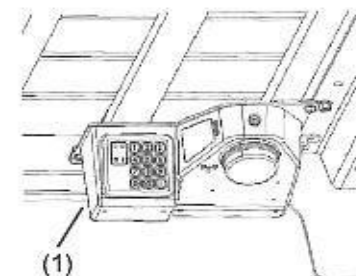
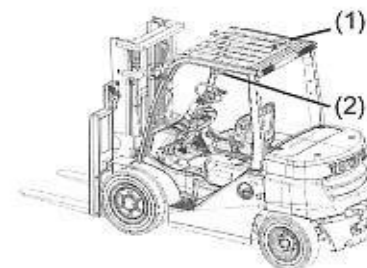

(1) Keypad, Data handling unit and antenna

(2) Pre-operation check display

Deluxe Cabin

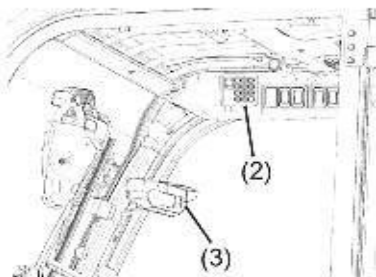

- (1) Data handling unit and antenna
- (2) Keypad
- (3) Pre-operation check display

⚠ CAUTION

Telematics emits radio waves. Do not use Telematics near medical equipment or explosives.

12.3.1 Login operation

1. The ignition key switch turn to ON position.
2. Enter the PIN

Each time the numeric key is pressed, the green LED illuminates for a short time to let the operator know that the key operation is valid.

3. Press the login switch.

The system checks if the entered PIN is registered or not.

4. The ignition key switch turn to Start position.

When the entered PIN is approved, the green LED illuminates.

When the entered PIN is not approved, the red LED illuminates for 1 second and the system returns to the logoff state.

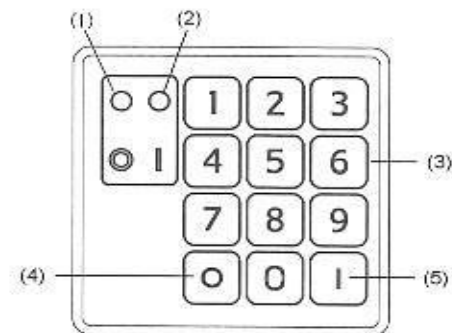

- (1) Red LED
- (2) Green LED
- (3) Numerical keypad
- (4) Logoff switch
- (5) Login switch.

⚠ CAUTION

When you log on to the truck, be sure that you are in the normal seated position with the seat belt fastened and the parking brake is applied. Otherwise, the truck may start suddenly, leading to an unexpected accident.

NOTICE

- In case the logoff switch is pressed before completing PIN entry, the login operation is canceled and the system returns to the logoff state.
- In case the login switch is pressed after over 5 digits are entered, the system reads the last 5 digits as PIN code.
- In case the login switch is pressed after less than 5 digits are entered, the system adds "0" at the top and read it as PIN code. (Example: "123" becomes "00123")
- If the truck is left without completing the login operation, entered code remains.
- If the buzzer sounds when the truck speed is more than 2km/h and the keypad's green LED is off, the operation data of the truck might not be recorded correctly. In this case, turn the key off and login again after a few seconds.

12.3.2 Logoff operation

After the truck is started, turn off the ignition key switch to send the truck into the logoff status.

NOTICE

The truck does not become to the logoff status even if you press the logoff switch.

12.3.3 Shock detection function setting

When this feature detects the intense shock on the truck, it warns the operator with the buzzer sound, and it records its impact value, date and time, and PIN code.



12 INSTRUMENT

NOTICE

- At the same time, the truck speed will be limited to creep speed. (1FS or 1KD engine equipped models).
- In case it is permitted by a supervisor and under certain condition, an operator can reset the buzzer
- A supervisor can change the shock detection level by using PC or mobile devices.

⚠ WARNING

- The strength of the shock generated on the truck depends on the objects where the truck collided. Not all of the collisions can be detected.
- The shock generated in the usual operation depends on the road conditions, the loads, and the load handling operations. To prevent detecting collisions in the usual operation, ask a supervisor for setting the detection level.

12.3.3.1 Shock detection function and Warning Operation

In the case shock exceeds the shock detection value set in either of the longitudinal or lateral direction, the buzzer sounds to warn the operator. Even if the operator turned the ignition key switch off or disconnected the battery once, the buzzer sounds to warn the operator and at the same time the truck speed will be limited to creep speed (1FS or 1KD engine equipped models).

In case it is permitted by a supervisor and the detected shock is under the preset value, an operator can reset the shock detection alarm by logging off and logging in again with the operator PIN code. If the detected shock exceeds the preset value, only a supervisor can reset the alarm.

12.3.4 Pre-operation check (Option:Telematics with POC)

12.3.4.1 Pre-operation check function

(POC: Pre-operation check)

The Pre-operation check function is a feature which records the pre-operation check results based on the checklists. It also limits the truck operation if anything unusual is found during the pre-operation check.

After logging in to the truck, operators need to respond to all questions in the checklist or the truck cannot be started. This option can help prevent the truck from being used without pre-operation check.

The pre-operation checklists are created by means of the website by a supervisor.

Up-to 20 question are stored in the checklist and each inspection item is marked as "Critical item" or "Non-critical item".

Pre-operation check display

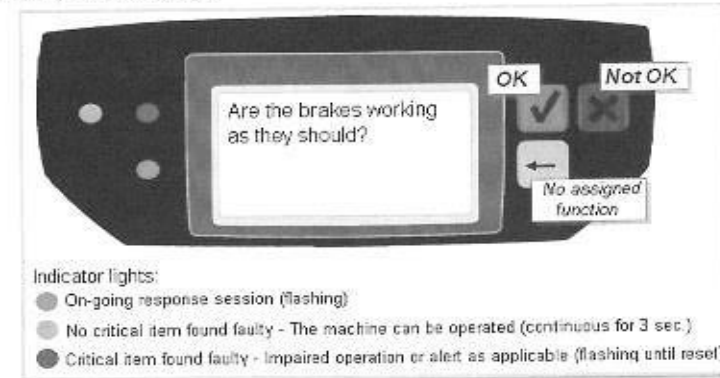

- The items or functions to be checked are shown in the display window.
- Respond to each questions by pressing either green button (OK) or red button (not OK).
- After you have responded to the question, the next question is shown in the display window.
- While responding, the amber light is flashing at 0.5 Hz.
- After you have responded to all questions, the system checks the responses and the result is indicated by color coded lights to the left of the display window:

Description of indicator lights

Green	All items and functions are in good condition or only non-critical items or functions were found faulty.	Continues illuminating for 3 seconds
Red	One or more critical items or functions were found faulty or the check-up was not completed properly (critical questions included). Truck operation may be limited(1FS or 1KD engine equipped models).	Flashing until reset
Amber	The check-up was not completed properly (critical questions not included). Truck operation will not be limited(1FS or 1KD engine equipped models).	Continues illuminating for 3 seconds



Pre-operation check procedure

1. Log in to the truck according to "Login operation" section of this manual.
2. The Pre-operation check function is activated and the first question appears on the display window in 2 to 3 seconds (default setting).

NOTICE

The Pre-operation check will not be activated, if:

- It is less than 12 hours since your last login with the same PIN code. (Except: The set of questions have been changed in the meantime, your previous pre-operational check was not completed properly due to turn off the ignition key switch.)
 - The Pre-operation function has not been activated from the website or no questions have been downloaded to the Pre-operation check display.
 - You have a supervisory function.
3. Respond to the questions as they show up on the display window.

When completed, a green light illuminates and truck operation is possible. If the red light is illuminated, the truck operation is limited until reset (1FS or 1KD engine equipped models).

With the red light, an alert message is sent to the server for prompt attention. The green light does not trigger an alert message but the information is sent to the server at a scheduled or requested communication instance.

NOTICE

The red light is triggered by:

- 'Not OK' on a critical question
 - Time Out (A response session has been aborted or left unattended for too long (more than 5 minutes))
 - Session Too Short (A response session has been completed too quickly. The inspection session should take at least 30 seconds to respond.)
4. At the end of the work, log off the truck according to "Logoff operation" section of this manual.

12.3.4.2 Messaging function

This feature allows you to send ad-hoc messages from the I_Site web application directly to the operator(s) / truck(s), which is convenient in remote or noisy sites where communication can be difficult.

To enable this function, it is necessary to enable the Pre-operation check in the "Machine Configuration" for each truck on I_Site.

Examples:

- Safety messages to all operators.
- Fleet manager allocating a job to a specific truck for the operator to accept and act on next time the truck is started.
- Call all operators to information meeting, allowing each operator to accept or reject the invite.

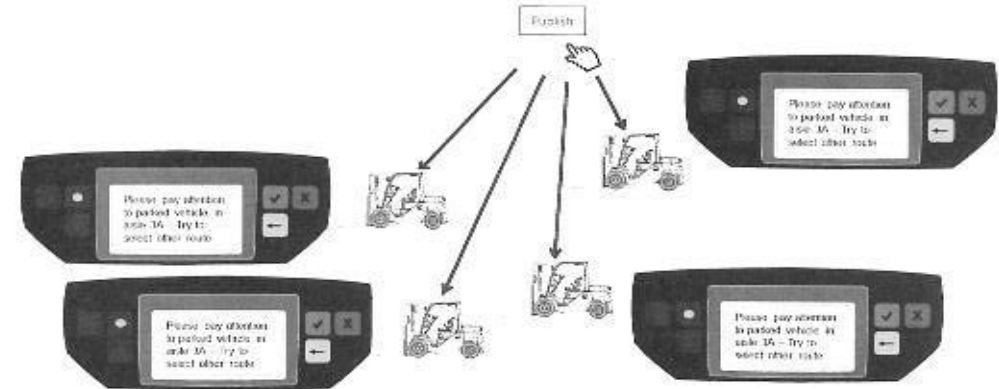

- If an operator is logged on (and a Pre-operation check is not ongoing) the message shall be shown immediately. At this time, the amber LED is flashing.
- The message is accepted by the operator by pressing the green button. The message is rejected by the operator by pressing the red button. After reply the message, display and amber LED turns off.
- If not expired, the message shall be shown at each log on of a new operator (but not to operators who have already accepted or rejected the message).
- If a Pre-operation check session is ongoing, the message shall be shown on the display 10 seconds after the Pre-operation check session has been completed.
- If the message is shown and the operator logs out without having accepted or rejected, the message is shown again at next log on (if not expired), even if it is the same operator.
- If timeout is reached without the operator having accepted or rejected the message, it shall be shown again at next log on (if not expired).
- Operator ID and timestamp for acceptance or rejection is reported to web server at next communication so maybe it will take some time to update the report.

13 LPG DEVICE (OPTION)

13 LPG DEVICE (OPTION)

Names of LPG device components

LPG tank

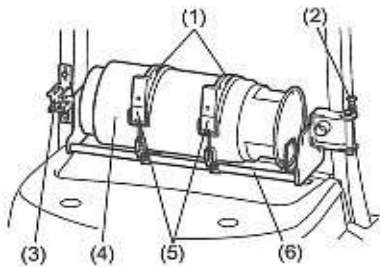

Regulator

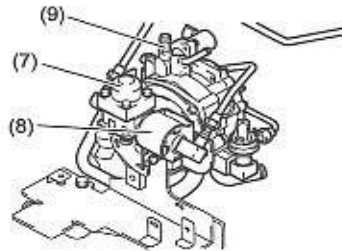

- | | |
|--------------------------|-------------------------|
| (1) Tank band | (6) Tank bracket |
| (2) Set pin (upper side) | (7) Filter |
| (3) Tank bracket stopper | (8) Main solenoid valve |
| (4) LPG tank | (9) Regulator |
| (5) Tank clamp | |

13.1 Switches

Fuel changeover switch (Gasoline-LPG models)

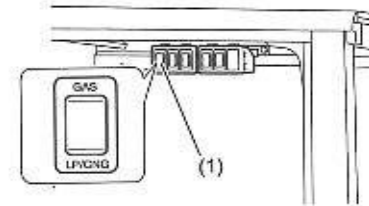

(1) Fuel changeover switch

This is a switch to select the type of fuel to be used (gasoline or LPG).

OFF - Horizontal position (Fuel is not supplied and the engine does not start up).

LPG - Lower position

GASOLINE - Upper position

NOTICE

If the key switch is turned off, fuel is not supplied to the engine even when the fuel changeover switch is positioned at LPG or GAS position.

LPG warning switch (Option)

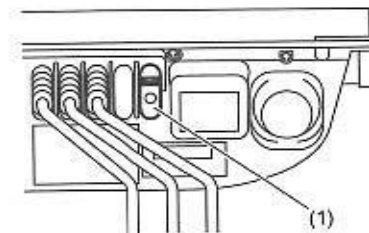

(1) LPG warning switch

When the LPG level inside LPG tank gets low, the warning lamp will come on and the warning sound will notify the operator.

When the fuel warning system operates, push the switch to stop the warning sound.

The lamp remains on until LPG is refueled.

NOTICE

- Once the fuel warning system sounds, always refuel.
- It is possible to travel for approximately 1.5 minutes (350 m [1148 ft]) after the warning system is operated. The feasible drive time varies depending on the type of operation being performed, ambient temperature and LPG composition, etc.



13.2 LPG related parts

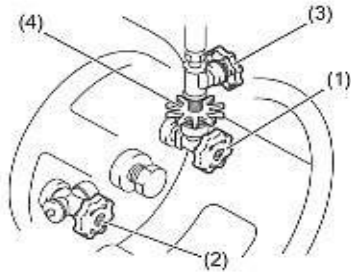

(1) Outflow valve

This valve controls the flow of LPG fuel from the LPG tank to the regulator.

To open the valve - turn it counterclockwise

To close the valve - turn it clockwise

(2) Inflow valve

LPG is filled in the tank through this valve. The tank must be filled by an LPG filling station attendant. Be sure that this valve is shut tightly at all times during use.

(3) Pipe valve

When the fuel hose needs to be disconnected for tank replacement, etc., close this valve to prevent the liquid from running out of the hose.

To open the valve - turn it counterclockwise

To close the valve - turn it clockwise

(4) Screw

Open this screw when the fuel hose needs to be disconnected for tank replacement, etc.

To open the valve - turn it clockwise

To close the valve - turn it counterclockwise

Relief Valve

This valve prevents explosion that might be caused when the LPG pressure rises above a normal level or when the hose becomes deteriorated.

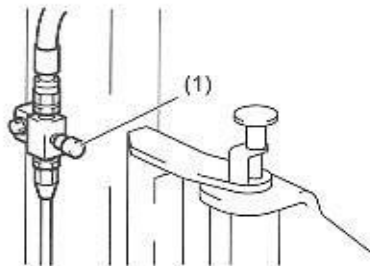

(1) Relief Valve

Swing type

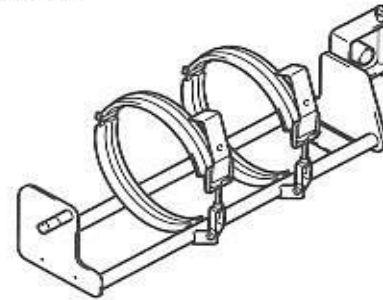

Swing-down type (Option)

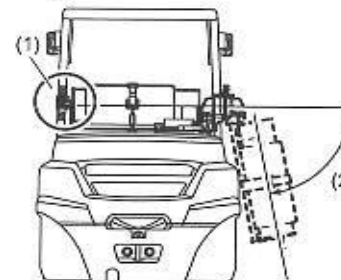
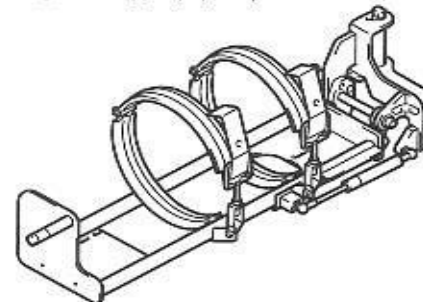

(1) Tank bracket stopper

(2) 65°

LPG tank bracket

LPG tank is securely locked on the tank bracket by the tank bracket stopper.

For swing-down type, LPG tank can be lowered at the angle up to 65°.

13 LPG DEVICE (OPTION)

13.3 Engine hood

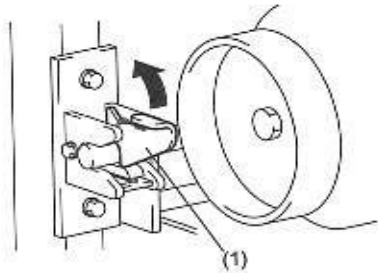

(1) Tank bracket stopper

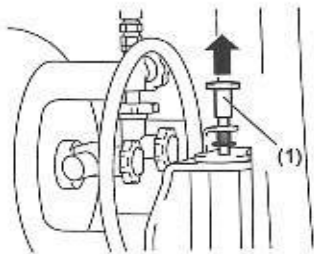

(1) Set pin (upper side)

Opening

1. Lift up the tank bracket stopper on the left tank bracket and release the lock.

2. Unlock the set pin (upper side) on the right side of the tank bracket, by lifting it, turn the bracket rearward, and fix the set pin.

⚠ WARNING

Shake the tank bracket and check that the set pin is applied securely.

3. Open the engine hood according to instructions in "BODY COMPONENTS" chapter.

Closing

Close the engine hood according to instructions in "BODY COMPONENTS" chapter.

13.4 Operating LPG-powered forklift

Starting the engine (LPG models)

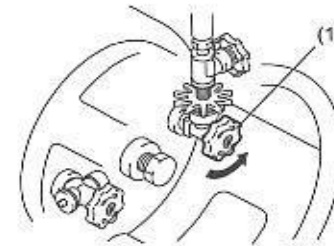

(1) Outflow valve

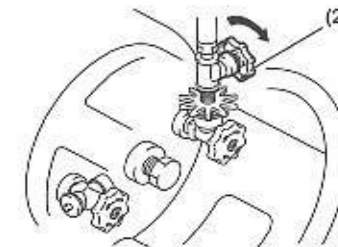

(2) Pipe valve

1. Set the direction control lever in the neutral position and apply the parking brake.
2. Turn the outflow valve of the tank counter-clockwise to open it.

3. Be sure that the pipe valve is open.

4. Wait for the engine to start running, and set the key switch to the ON position.
5. Let the engine idle for 5 to 6 minutes.

⚠ CAUTION

- Never depress the accelerator pedal repeatedly or hold it down completely during starting. The engine will not start easily.
- Never depress the accelerator pedal completely. It will send an extra amount of LPG and may freeze the regulator and damage the engine.



Starting the engine (Gasoline-LPG models)

If the ambient temperature is sufficiently high:

- Start the engine the same way as you would start the engine of LPG models.

If the temperature is very low and starting engine with LPG fuel is difficult:

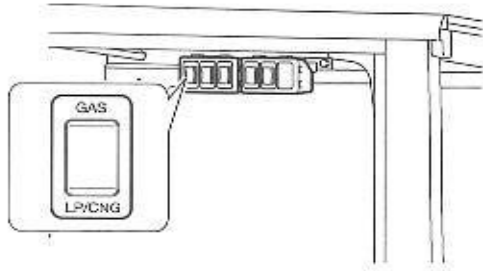

1. Set the control lever in the neutral position and apply the parking brake.
2. Set the fuel changeover switch to the GAS position.
3. Start and warm up the engine as you would start and warm up a gasoline engine.
4. Set the fuel changeover switch to the OFF position (horizontal position) and let the engine stop in the idle state.

⚠ CAUTION

Never change the fuel changeover switch setting from GAS to LPG positions while the engine is running. It will increase the engine RPM sharply and cause serious damage to the engine.

5. Set the fuel changeover switch in the LPG position. It must be left in that position for starting the engine and during use of the truck.
6. Start the engine again as you would start the engine of LPG models.

When the engine will not start easily:

Even if the LPG system is working properly, too lean or rich LPG makes engine starting difficult.

When LPG gas is rich:

Depress the accelerator pedal and start the engine again.

⚠ CAUTION

- If engine starting fails, wait for about 2 minutes. Further cranking will make LPG more rich and make starting impossible.
- If the engine still does not start, ask your supervisor to get a professional service staff to make repairs or ask the Toyota dealer.

To Prolong the Engine Life:

Refrain from handling and driving the truck roughly especially when it is new.

Parking

⚠ CAUTION

- Park LPG-powered trucks only in well ventilated area.



When parking for a short time:

1. For Gasoline-LPG models, turn the fuel changeover switch to the OFF position (horizontal position).
2. Let the engine stop in the idle state so that any LPG fuel in the piping leaves the system. Turn off the key switch and remove the key.

When parking for a long time:

1. Turn the LPG tank outflow valve clockwise to shut the fuel supply.
2. Let the engine stop in the idle state so that any LPG fuel in the piping leaves the system. Turn off the fuel changeover switch (Gasoline-LPG models) and the key switch. Remove the key.

13.5 Refueling your truck

⚠ DANGER

Under no circumstances what so ever may the LPG tank replacement be performed near a lighted cigarette, lighted match, gas stove burner, electric heater, motor or any other electric appliance that emits sparks, flame or any type of fire (referred to collectively as "fire" below).

To avoid serious injury from fire or explosion, you must follow these rules:

- Turn off the key switch and lights.
- Change tanks only in well ventilated, approved areas.
- No fire or flames allowed.
- Check all connections for damage or missing parts.
- Check for leaks.
- Do not restart until all smell of gas is gone.
- If truck will not restart, ask the Toyota dealer to inspect it.
- Filling tanks requires special procedures and trained personnel.



13 LPG DEVICE (OPTION)

13.5.1 LPG refueling

- LPG is heavier than air, and can accumulate in low areas and even on clothing. Any flame or spark can cause a fire and lead to a serious accident.
- Always refuel in the designated area. Check that the supplier is equipped with proper connections to ensure a secure supply.
- Always exchange tanks when refueling with LPG.
- When exchanging LPG tanks, always visually check the connections for damage or other abnormalities. Be careful so that the LPG hose will not be caught by the tank or bracket. If a gas leak occurs, do not start the engine and request repairs immediately.
- When the LPG tank needs refilling, ask the LPG station attendant to fill the tank. Never attempt to fill the tank yourself. This is extremely dangerous.

13.5.2 Removing the LPG tank

⚠ WARNING

- You must be trained and authorised to replace the tank.
- Wear leather gloves or other protective equipment when replacing the LPG tank. LPG can freeze hands and fingers in case the gas leaks.

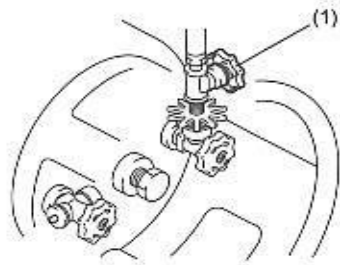

(1) Pipe valve

1. Stop the engine according to instructions for "When parking for a long time".

2. Turn the pipe valve clockwise to shut it.
3. Disconnect the piping from the LPG tank (turn the screw counterclockwise).

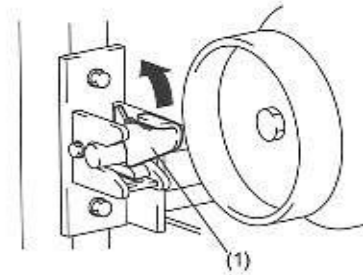
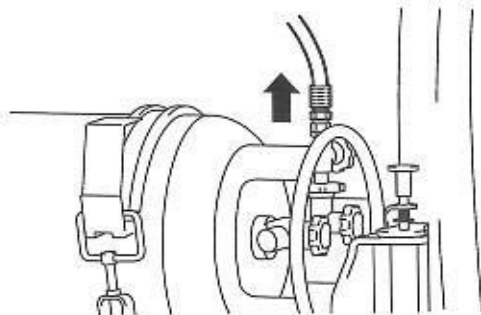

(1) Tank bracket stopper

4. Lift up the tank bracket stopper on the left tank bracket and release the lock.

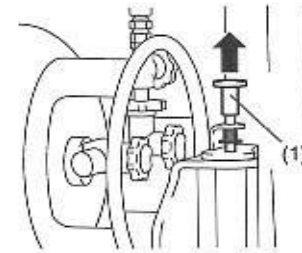

(1) Set pin (upper side)

5. Unlock the set pin (upper side) on the right side of the tank bracket, by lifting it, turn the bracket rearward, and fix the set pin.

⚠ WARNING

Shake the tank bracket and check that the set pin is applied securely.

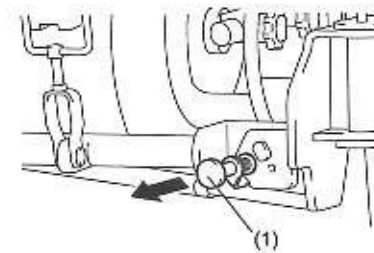

(1) Set pin (lower side)

6. For swing-down type, pull the set pin (lower side) on the lower side of the tank bracket for unlocking. Lower the tank bracket and fix the set pin.

⚠ WARNING

When unlocking the tank bracket set pin, never enter the area under the tank bracket. Pay special attention as the tank bracket may lower due to its own weight.

⚠ WARNING

Never unlock the set pin when the tank is full. Otherwise, it may cause the tank bracket to lower suddenly, which can cause personal injury.



Swing type

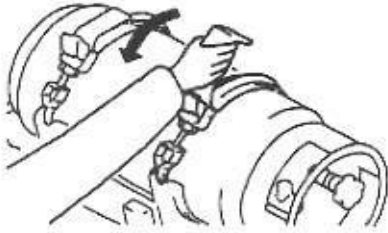

7. Pull the tank clamp toward you and unlock the tank bands.

Swing-down type

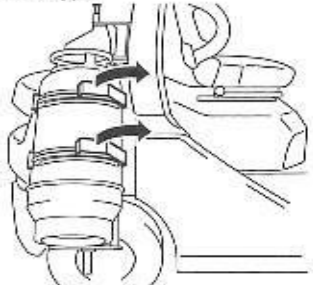

Swing type



8. Raise the tank bands away from you and remove the LPG tank.

Swing-down type



13.5.3 Installing LPG tank

⚠ WARNING

- You must be trained and authorised to replace the tank.
- Wear leather gloves or other protective equipment when replacing the LPG tank. LPG can freeze hands and fingers in case the gas leaks.

Swing type

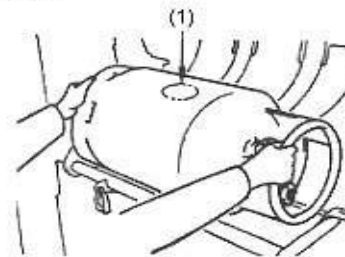

1. Put the LPG tank on the bracket. The tank must be placed with the correct side up. Find a hole for indexing pin or marking on the tank. It must face upward or rearward.

Swing-down type

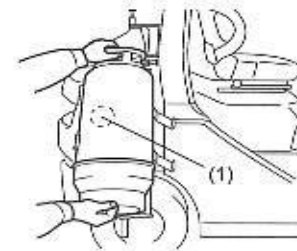

(1) Marking



13 LPG DEVICE (OPTION)

Swing type

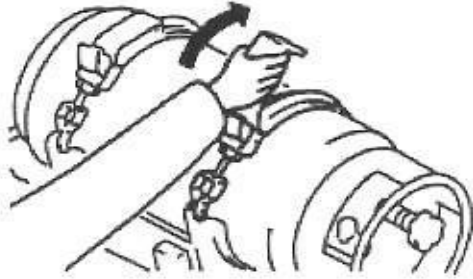

- Put bands over the tank, hook clamps to bands and push clamps up to clamp the tank.

Swing-down type

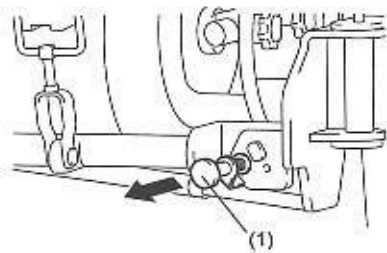
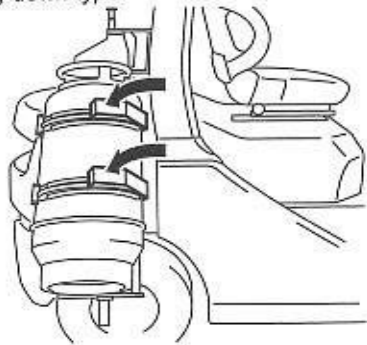

(1) Set pin (lower side)

- For swing-down type, unlock the tank bracket by pulling the set pin (lower side) under the tank bracket. Raise the tank bracket and fix the set pin.

WARNING

It is dangerous to unlock the set pin without a full tank because the bracket may raise up suddenly due to the spring force. To raise the bracket unlock the set pin only when there is a full tank on the bracket. Remove the set pin, turn the tank bracket around the pivot and ensure the bracket stopper knob is securing the bracket in place.

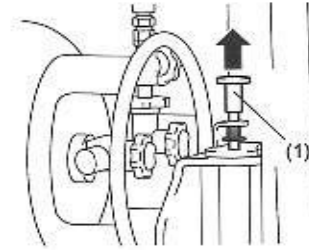

(1) Set pin (upper side)

- Pull up the set pin (upper side) to swing the tank bracket. Fix the set pin with the bracket stopper on the left tank bracket.

WARNING

Check the tank outlet and coupling to make sure all seals are in place and undamaged.

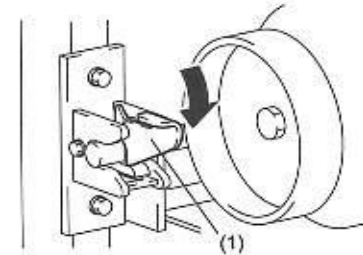

(1) Tank stopper bracket

WARNING

Make sure that the tank bracket stopper is securely in place.

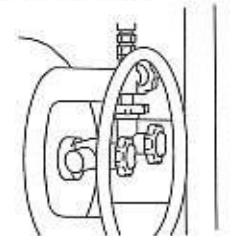

- Connect the piping to the outflow valve of the tank (turn the screw counterclockwise).

- Wet the pipe connection to the tank with soap water or neutral detergent. Open the outflow valve and check the connection for any gas leaks.

WARNING

If any gas leakage is found, immediately report it to a supervisor for repair by a qualified mechanic or the Toyota dealer. Tag truck "out of service".



7. Do not try to start engine until all gas smell is gone.
8. Wipe off the soap water or detergent after inspection is completed.

13.6 Important information about LPG

- LPG normally contains a substance that gives it a noticeable odor in concentration of 1/200 or more in air.

If a large amount of the LPG is leaking from the tank, it can be detected by the smell. LPG does not contain carbon monoxide and is not poisonous although it is explosive.

- LPG is a highly pressurized gas and leaks very easily.

The vapor has a volume 250 times that of the liquefied gas and it is twice as dense as air. Therefore, it collects in low places.

- LPG increases in pressure as the temperature increases.

13.7 Safety precautions on LPG-powered forklifts

- LPG is flammable. A tiny spark can cause a fatal explosion if it is handled carelessly. It is very crucial that the following precautions are observed most strictly to avoid hazards.
- Only operate a LPG-powered forklift in a well ventilated area.
- All LPG-powered forklifts must be operated and maintained (including the LPG tank renewal) by designated persons only.
- Never stop or park an LPG-powered forklift near fire.
- Do not operate an LPG-powered forklift in the presence of fire.
- When operating or inspecting an LPG-powered forklift, post a large "FIRE HAZARD" sign and make sure that persons using fire do not approach the vehicle.
- Remove the ignition key from an LPG-powered forklift before parking or storing it so that no unauthorized person can operate it.
- Use only soap water or neutral detergent to check the vehicle for gas leaks. Do not use any other fluid.
- If the gas leak inspection must be performed at night with the help of a flashlight, turn the flashlight on far away from the vehicle and walk toward it. The flashlight might cause a spark when it is turned on and cause an accident.
- If a gas leak is detected, immediately put out any fire, ventilate the area and keep the area in a strictly fire free condition. Then call a qualified Toyota dealer or service garage.
- Store LPG tanks in a strictly predetermined area equipped with a gas detector at all times.
- Have LPG tanks refilled only by an LPG gas filling station attendant.
- Use LPG of an appropriate chemical composition according to the climate. In cold climate, use LPG with a relatively high propane content.



14 PRE-OPERATION CHECK

14 PRE-OPERATION CHECK

Be sure to inspect trucks at the start of every shift. These and other periodic inspections are your responsibility and these guidelines are to assist you in your job.

Item	Inspection
Previously detected malfunctions	Correct
Exterior	Body, oil leakage, water leakage, loose parts and exterior damage
Overhead guard	Bends, cracks and looseness
Wheels	Tire pressure, wear or damage, rims and hub nuts
Lights	Light condition and damaged lights
Rear-view mirror	Damage, adjustment
Nameplate, warning labels	In-place, clean, legible
Hydraulic oil	Oil level, contamination and consistency
Radiator	Coolant level and anti-freeze requirement.
Engine	Oil level, contamination, consistency, noise and exhaust
LPG	Damage and gas leakage
Inching and brake pedal	Pedal play and braking effect
Parking brake	Operating force and brake effect
Operator restraint device	Seat belt damage (cut or frayed straps, loose stitching), tongue damage, buckle and retractor damage
Instruments	Functioning
Fuel	Amount and any leaks
Steering wheel	Looseness, play, vibration
Load handling system	Parts, oil leakage, damaged hoses, cracking and looseness Make certain that the SAS and clamp release interlock (Option) is functioning
Load backrest	Bends, cracks and looseness
Horn	Sound

14.1 Walkaround inspection

14.1.1 Alignment

Does the truck lean to one side or the other? If so, check for flat tire or a problem with the undercarriage.

14.1.2 Beneath the truck

Check for any oil or coolant leakage on the ground or floor where the truck was parked. Check for loose parts or damage.

If any unusual condition is found, have the truck inspected. The Toyota dealer can provide this inspection.

14.1.3 Tire inspection

Damage, cracking and wear of tires and rims

Check the tires for damage and wear, and the rims for damage.

⚠ CAUTION

If the tires are damaged, or there is a marked difference in tire wear between front and rear or between left and right, or damaged rims are found, you should request an inspection from an authorized Toyota dealer. Damaged or low tires could cause the tire to burst or skid.

Inflation pressure of tires

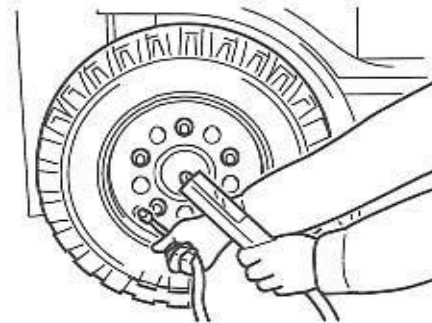

1. Use a tire pressure gauge and measure the inflation pressure. Adjust it to the proper pressure.

⚠ CAUTION

Do not raise the pressure beyond the proper level.

NOTICE

See the SERVICE DATA section of this manual for the proper inflation pressure.

2. After adjustment, check for air leakage from the valve.

14.1.4 Hub nut inspection

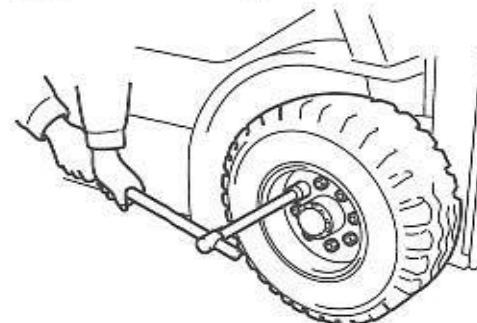

Check the tightness of the hub nuts. Avoid uneven torque and tighten all of the nuts uniformly.

NOTICE

Refer to SERVICE DATA section of this manual for proper tightening torque.



14.1.5 Overhead guard inspection

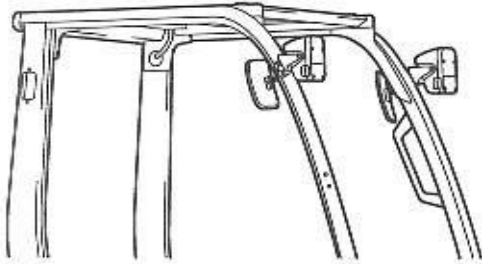

Check the overhead guard for bends, cracks and looseness.

14.1.6 Light inspection

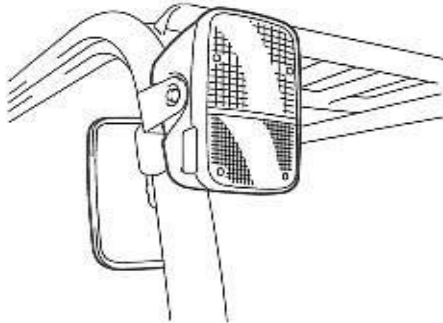

Are the lights working? Is there any lens damage? Always keep the lenses clean to insure proper vision.
(Turn signal lights and rear-view mirrors are optional)

14.1.7 Rear view mirror inspection

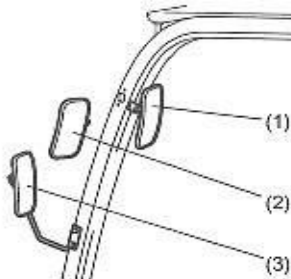

Check the rear view mirror for any damage and adjust the mirror angle before operating the truck.

- (1) Rear view mirror
- (2) Rear view mirror for models with Low head guard (Option)
- (3) Rear view mirror for models with Cabin (Option)

⚠ CAUTION

To avoid accidents, adjust the mirror angle before operating the truck. Never adjust the mirror angle while the truck is moving.

14.1.8 Nameplate and warning labels inspection

Check the nameplate and warning labels if they are in-place, clean and can be read.

If the nameplate or warning labels are missing, damaged or illegible, ask a supervisor or the Toyota dealer and replace them.

14.2 Engine compartment inspection

14.2.1 Checking the engine coolant level in the reservoir tank

⚠ WARNING

Level check and supply of engine coolant shall be performed while the coolant is cool.

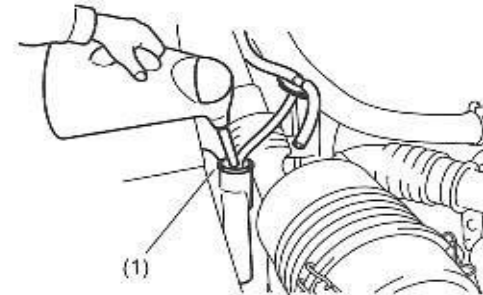

(1) Reservoir tank

1. With the engine off, open the engine hood and check the engine coolant level in the reservoir tank.

NOTICE

The reservoir tank automatically supplies the engine coolant when the level in the radiator is low.

2. The coolant level is correct if it is between the upper and lower limits. If the level is below the lower limit, supply coolant to the upper limit.

NOTICE

The concentration of the long-life coolant (LLC) in the engine coolant must be 50%.

3. If coolant supply is frequently required, the cooling system may be leaky. Conduct an inspection immediately.

⚠ CAUTION

If no engine coolant remains in the reservoir tank, be sure to check the coolant level in the radiator, but only when cool.



14 PRE-OPERATION CHECK

14.2.2 Checking the engine coolant level in radiator

⚠ WARNING

Coolant level checks must always be performed when the radiator is cold. Removing the cap when engine is hot can cause serious injury.

⚠ CAUTION

Check the coolant level in the radiator only when no engine coolant remains in the reservoir tank.

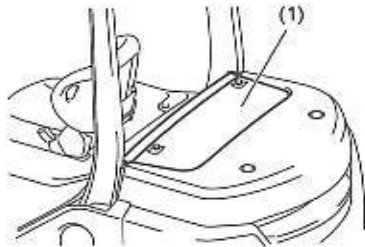

(1) Radiator cover

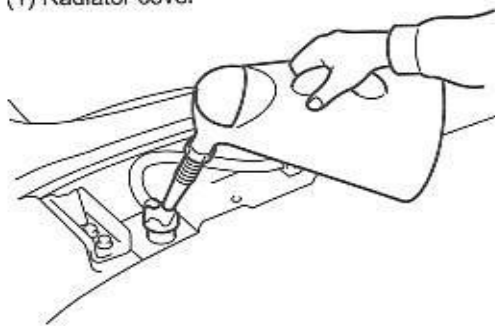

1. Remove the rear side radiator cover.
2. Remove the cap and check the coolant level from the filler port.
3. If the engine coolant is not visible through the filler port, add an appropriately amount of diluted coolant (LLC).
4. To close and tighten the radiator cap, match the pawl on the reverse side of the cap with the notch in the filler port and turn the cap fully clockwise while pressing it down.

14.2.3 Checking hydraulic oil level

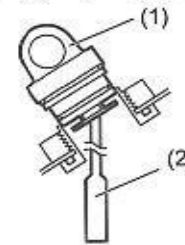
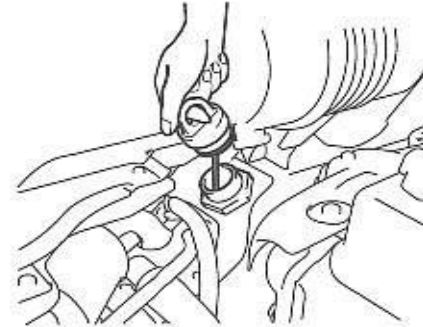

(1) Oil cap
(2) Oil level gauge

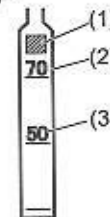

(1) Identification marking
(2) Lift height 5,500 - 7,000 mm
(3) Lift height 5,000 mm or less

1. Always stop the engine and lower the forks to the ground before checking the level of the hydraulic oil while the truck is on level ground.
2. Open the engine hood and remove the oil cap.
3. Wipe the level gauge attached to the oil cap with a clean cloth, and insert it again into the tank.
4. Remove the level gauge gently and check if the oil is up to the level line.

NOTICE

Inspect the oil level by placing the level gauge on the opening of the oil supply inlet, without pushing the oil cap in.

NOTICE

The oil level varies with the maximum lift height.

5. If the oil level is insufficient, add oil. Spilled and splashed oil must be wiped off thoroughly.

Identification marking	Applicable models
35, 40	8FG35N, 40N 40-8FD35N, 40N
45, 80	8FG45N-80N 40-8FD45N-80N

14.2.4 Engine oil inspection

1FS (Gasoline) Engine

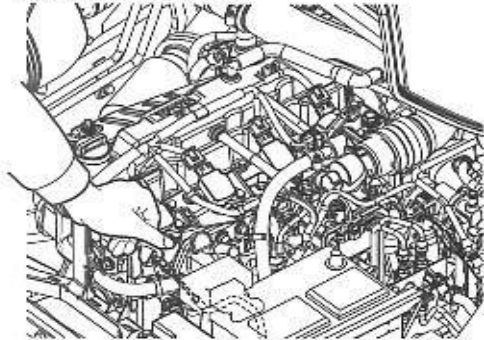

1KD (Diesel) Engine

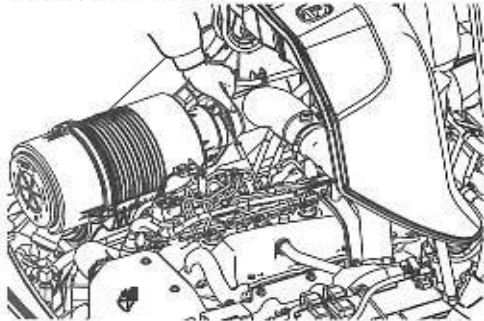

Oil level gauge



1. Park the truck on level ground. If the truck is inclined, the indicated level may be incorrect.
2. Open the engine hood. (Refer to "Engine hood" section of this manual)
3. The oil level must be checked before starting the engine or at least 5 minutes after the engine has stopped.

4. Remove the oil level gauge and wipe it with a clean cloth. Insert it again and check if the oil level is between the F and L levels.
5. If the oil level is below the L line, add oil to the F line.

14.2.5 Adding engine oil

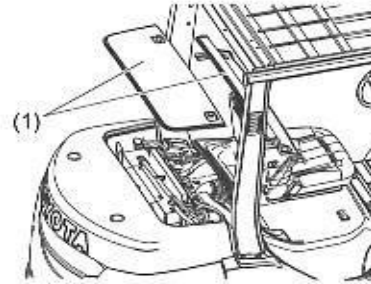

(1) Radiator covers

1FS (Gasoline) Engine

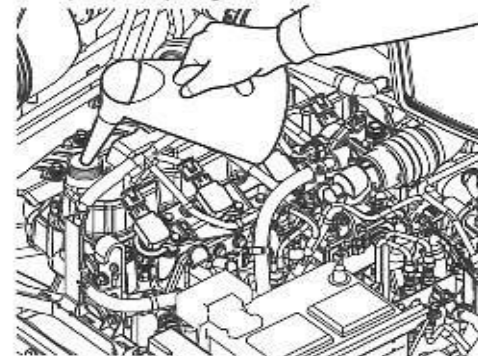

1KD (Diesel) Engine

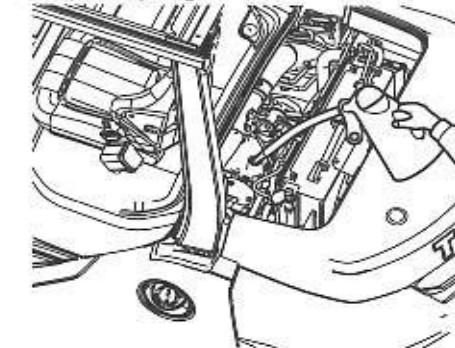

1. For diesel engine model, remove the front and rear side radiator cover.
 2. To supply oil, remove the filler cap and pour oil through the filler port. Never let the oil level exceed the F line.
 3. Refer to the RECOMMENDED LUBRICANT QUANTITY & TYPES section of this manual for the recommended types of engine oil for replacement. RECOMMENDED LUBRICANT QUANTITY & TYPES
- CAUTION**
Always use the same brand of oil.



14 PRE-OPERATION CHECK

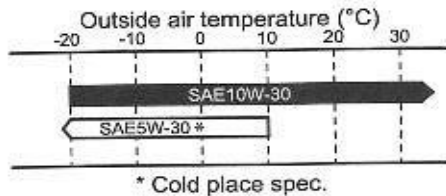

The oil to be supplied must be appropriate for the season.

1FS : SAE10W-30

1KD: SAE 10W-30, SAE5W-30

Ask the Toyota dealer to advise if any problems are found.

14.2.6 Leakage inspection

⚠ CAUTION

Always stop the engine before carrying out the leakage inspection.

Check the engine compartment for any oil or fuel leakage.

Clean the radiator if it is clogged and check if there are any foreign objects, such as paper, on the radiator grill.

14.2.7 LPG leakage inspection (Option: LPG and Gasoline-LPG models)

⚠ DANGER

To avoid serious injury from fire or explosion, you must follow these rules;

- Turn the key switch and lights off.
- Check for leaks only in well ventilated, approved areas.
- No smoking, fire or flames allowed. Make certain that there is no source of fire in the area throughout the gas leak check.
- To check for leaks, only use soap water or neutral detergent. Never use open flame or other liquids for leak checks.
- Do not try to start engine until all gas smell has gone.
- If any gas leakage is found, immediately report it to a supervisor for repair by a qualified service staff or the Toyota dealer. The truck is not allowed to be operated until the repair is completed.

Inspect for any LPG leakage before starting operation by the following procedure:

1. Open the outflow valve by turning counterclockwise.
2. Be sure that the pipe valve is open.
3. Operate the fuel changeover switch between LPG and the OFF repeatedly for several times, and leave it in the OFF position finally (only for Gasoline-LPG models).
4. Wet all hoses and the LPG tank and regulator connections with soap water or neutral detergent. Look for gas leak. Bubbles will show leaks.
 - Tag truck "out of service" if any leaks are found and immediately report to a supervisor.
5. After the gas leak check is completed, wipe off the soap water or neutral detergent from the wet parts.

14.3 On board truck inspection

14.3.1 Brake pedal inspection

NOTICE

The brake pedal must be inspected after starting the engine.

NOTICE

Ensure rubber pad is in place on the pedal.

1. Depress the brake pedal fully, and check the floor clearance (clearance between the pedal and floor).

NOTICE

See the SERVICE DATA section of this manual for the floor clearance.

2. Make sure that the pedal does not go any further when it is kept depressed.
3. Also check that no problem is observed with pedal depression and return.
4. Manually depress the brake pedal to check the play until a resistance is felt.

NOTICE

See the SERVICE DATA section of this manual for the amount of brake pedal play.

⚠ WARNING

Ask the Toyota dealer for an inspection if play is excessive, pedal movement has a problem or brake performance is not normal.

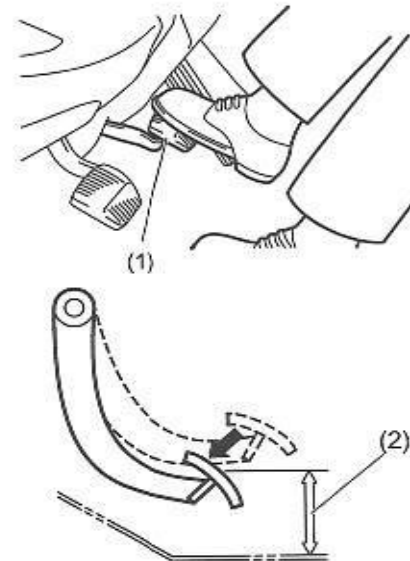

- (1) Brake pedal
(2) Floor clearance

14.3.2 Inching pedal inspection

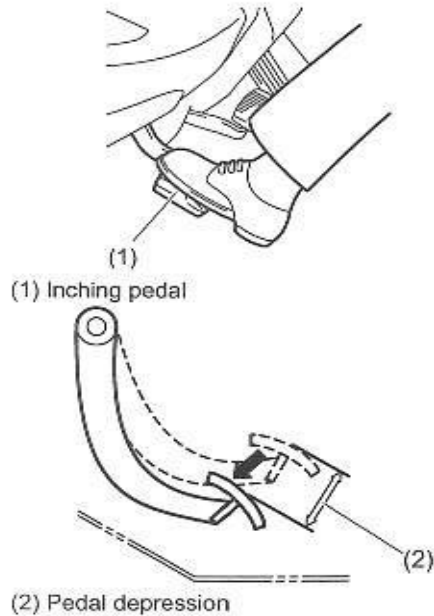

NOTICE
Ensure rubber pad is in place on the pedal.

1. Depress the inching pedal and check if you feel a click under your foot.
- NOTICE**
See the **SERVICE DATA** section of this manual for the amount of pedal depression.
2. Also check that no problem is observed with pedal depression and return.
- ⚠WARNING**
Ask the Toyota dealer for an inspection if pedal movement has a problem.

14.3.3 Brake and inching pedal inspection (Option: EZ pedal)

NOTICE
Ensure rubber pad is in place on the pedal.

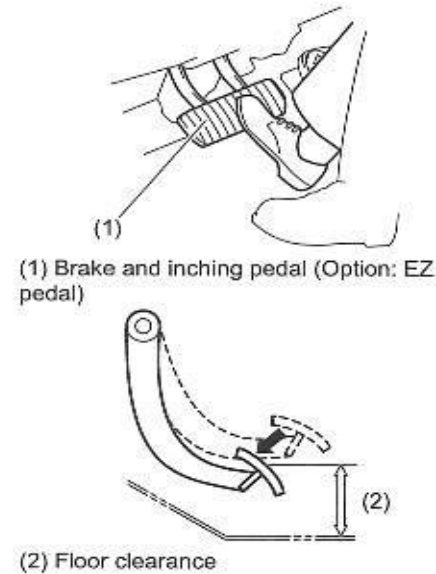

1. Depress the brake and inching pedal fully, and check the floor clearance (clearance between the pedal and floor).

NOTICE
See the **SERVICE DATA** section of this manual for the floor clearance.

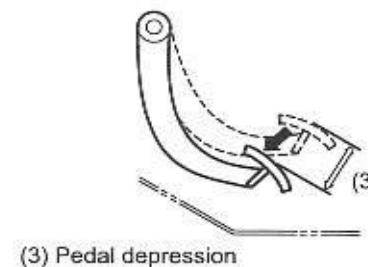

2. Depress the brake and inching pedal and check if you feel the click under the feet.
- NOTICE**
See the **SERVICE DATA** section of this manual for the amount of pedal depression.
3. Also check that no problem is observed with pedal depression and return.
- ⚠WARNING**
Ask the Toyota dealer for an inspection if pedal movement has a problem or brake performance is not normal.



14 PRE-OPERATION CHECK

14.3.4 Parking brake lever inspection

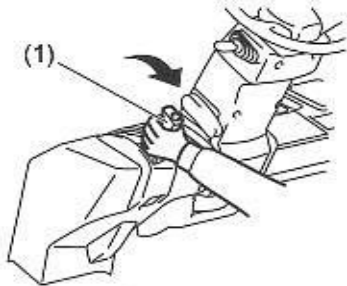

(1) Parking brake lever

1. Pull the parking brake lever fully and insure that the brake is functioning normally.
2. Check the operating force required for pulling the parking brake lever. For the adjustment, see the section entitled "Adjusting of parking brake operation force" of this manual.

NOTICE

See the **SERVICE DATA** section of this manual for the parking brake operating force.

⚠ WARNING

Ask the Toyota dealer for an inspection if any abnormality is found.

14.3.5 OPS indicator inspection



Sit on the seat, start the engine, and check that the OPS indicator lamp is not illuminated.

⚠ CAUTION

In any of the following cases, a malfunction may have occurred to the OPS. Park the truck in a safe location, apply the parking brake, remove the key and ask the Toyota dealer for an inspection.

- The OPS indicator lamp does not illuminate when the operator is not seated in the normal operating position.
- The OPS indicator lamp does not go off when the operator is in the normal operating position.

14.3.6 Instrument inspection

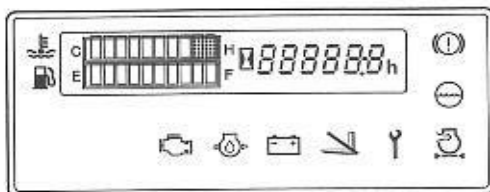

Start the engine and see that they operate properly.

14.3.7 Fuel level check and supply (Gasoline and diesel models)

⚠ DANGER

Follow these rules when refueling to avoid serious injury or death:

- Refuel only in authorized areas
- Turn the key switch off
- No smoking or naked flames allowed
- Clean up spills before starting the engine



1. Check the gauge to see if the fuel is sufficient to finish your shift.

NOTICE

After the end of daily operation, fill the tank with fuel to prevent moisture in the tank from mixing with the fuel.

2. When filling the fuel tank, stop the engine, remove the fuel tank cap by turning it counterclockwise, and pour fuel through the fuel filler neck.
3. After fueling, be sure to tighten the fuel tank cap.

⚠ CAUTION

Prevent entrance of water and dirt into the tank during fueling, use only clean, properly marked containers.

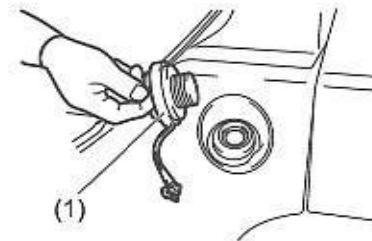

(1) Fuel tank cap

14.3.7.1 Fuel cap with key (Option)



The fuel cap can be locked by the dedicated key.

(The key is not the same as an ignition key switch or cabin door key.)

Gasoline fuel recommendation

Use only un-leaded gasoline of 89 octane (RON89) rating or higher.

⚠ CAUTION

If any other kind of fuel is used, it may cause a serious damage to the engine.



NOTICE

- Do not use gasoline with more than 10% Ethanol (E10) or engine/fuel system damage may occur.
- Do not use deteriorated fuel which has been stored for a long period of time or impure fuel in which foreign material, water etc. is included.

Diesel fuel recommendation

Use only ultra low-sulfur fuel defined by EN590: 2013.

Refer to the following table for details.

Detailed Requirement for EN590: 2013

Property	Unit	Lower Limit	Upper Limit
Distillation Temperature 95% (V/V)	°C	-	360
Kinematic Viscosity at 40°C	mm ² /s	2.0	4.5
Sulfur	ppm (mg/kg)	-	10
Cetane number		51	-
Cetane index		46	-
Polycyclic aromatic hydrocarbons	% (m/m)	-	8
Lubricity, HFFR at 60°C	µ m	-	460
Density at 15°C	kg/m ³	820	845

⚠ CAUTION

If any other kind of fuel is used, it may cause a serious damage to the engine.

NOTICE

- In cold weather, use winter diesel fuel to prevent clogging of the fuel filter caused by paraffin precipitation. In hot weather, do not use winter diesel fuel. Damage to engine will occur.
- Do not use deteriorated fuel which has been stored for a long period of time or impure fuel in which foreign material, water etc. is included.

14.3.8 Fuel tank check

Check fuel tank, tank covering, fuel inlet, and drain plug against possible fuel leak. Follow the steps below.

1. Try to smell leak.
2. Look for leak.

See the nearest Toyota dealer upon finding leak and have them repair tank immediately.

⚠ CAUTION

Never perform do-it-yourself welding or other repair work for it might cause explosion or fire.

14.3.9 Engine inspection



1. Start the engine and warm it up sufficiently.
2. Check each meter and warning lamp to see if there is any problem.
3. Check if the engine is making an abnormal sound or vibration.
4. Check the exhaust gas color to see if it is normal. If the exhaust gas color is colorless or light blue, the engine condition is normal. If not (e.g. black or white), ask the Toyota dealer for an inspection.

⚠ WARNING

- The exhaust gas can cause serious injury if inhaled, if you must start the engine inside building or enclosure, insure sufficient ventilation. Leave the building or enclosure as soon as possible after starting the engine.
- The engine in the idle state revs up at a relatively high speed when cold. The engine resumes normal speed when it is fully warmed.

14.3.10 Load handling system inspection



1. Check the forks and load backrest for cracks and bending.
2. Check for mast distortion, chain tension, and oil leakage from cylinders and piping.
3. Operate the lift and tilt levers to check their operation. If anything unusual is found, have the truck inspected at the Toyota dealer.

⚠ WARNING

Never check for oil leaks by hand. Oil under pressure can penetrate your skin causing a severe injury. Wear gloves and use a piece of cardboard to find leaks.



14 PRE-OPERATION CHECK

14.3.11 Checking and adjusting chain tension

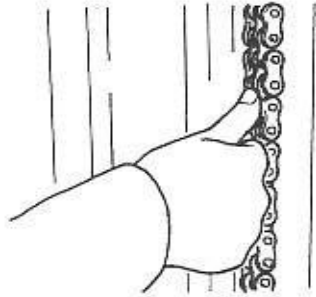

With the truck parked on a level surface and the forks raised about 20 - 30 cm (10 in.) above the ground, check the chains for tension differences by pressing each chain with thumb or by noting the tilt in forks rail. If the chains do not have the same amount of tension, ask the Toyota dealer to adjust.

14.3.12 Steering wheel and horn button inspection

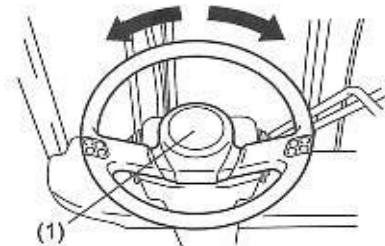

(1) Horn button of steering wheel

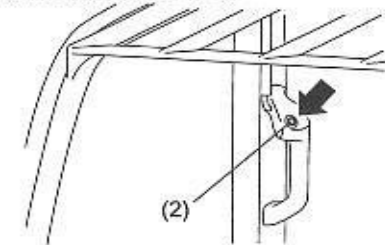

(2) Horn button of rear assist grip (Option)

NOTICE

Perform the inspection after starting the engine.

1. Check steering wheel play with the rear wheels set for straight travel.

NOTICE

See the **SERVICE DATA** section of this manual for the standard steering wheel play.

2. Rotate the steering wheel and also move it up and down to check that there is no looseness.
3. Push the horn button to check if the horn sounds normally.
4. If any problems are found, ask the Toyota dealer to inspect.

14.4 While moving slowly

14.4.1 Torque converter clutch disengagement

Press the inching pedal and check the clutch engagement while moving.

Inspection result	Condition
Truck travels even when the inching pedal is fully depressed	Disengagement issue
Truck does not increase traveling speed	Clutch slipping

CAUTION

Insure that the direction control lever operates properly and then make the above checks while moving slowly.

14.4.2 Steering inspection

While moving the truck slowly in a safe location, turn the steering wheel to the left and right and check for any unusual movement.

14.4.3 Brake effectiveness

Inspect to see if there is anything unusual when the brake pedal is pressed or if the brakes only work on one side.

Apply the parking brake on and insure that the truck can be stopped and held against moderate engine speed.

WARNING

If you should feel something abnormal even slightly, stop the truck operation immediately and have the truck inspected by the Toyota dealer.

14.4.4 Inspecting SAS

Check the SAS function to make certain that it is functioning properly.

Check the mast to make certain that it can be properly tilted either forward or backward and moved up. Also, make certain that the automatic fork leveling control is functioning properly.

CAUTION

If you should feel something abnormal even slightly, or when the spanner indicator lamp illuminates or blinks, or once an error code has appeared on the hour-meter display, immediately stop the operation in progress and park the truck in a safe location, apply parking brake and remove the key. Then, ask the Toyota dealer for an inspection.



15 STORAGE

At the end of every shift, remove dirt from all truck components and then perform the following:

1. Inspect for oil and water leakage.
2. Inspect each component for warping, scratches, dents or cracks.
3. Clean the air filter element and lubricate parts as required.
4. Clean the fuel inlet, oil filler holes and oil level gauges to avoid dirt to get into.
5. Move the forks all the way up and down the mast to lubricate the inside of the lift cylinder.

⚠ WARNING

Even a small malfunction can cause a serious accident.

- Report any damage, malfunction, unusual or unsafe condition to your supervisor or the Toyota dealer immediately.
- Do not use the truck until it is repaired by the qualified service staff or at the Toyota dealer.

NOTICE

Performing inspections at the end of work will lead to early detection of failures and prevents malfunction of the truck.



16 OPERATOR MAINTENANCE

16.1 Changing tires

⚠ CAUTION

- Use proper safety precautions when jacking the truck. Never get under the forks or frame.
- In the case of a wheel with a divided rim, do not loosen the rim bolts and nuts when loosening the hub nuts. When loosening the rim nuts or removing the rim bolts, be sure to completely remove the air before loosening.
- Refer to SERVICE DATA section of this manual for hub nut tightening torque and tire air pressure.
- Tire air pressure is very high, so pay attention to rim damage, cracks, etc. Never exceed proper air pressure.
- Do not replace any tire without turning on the key switch before jacking up the truck. Upon completion of the tire replacement, return the key switch to the OFF position.

Front wheels

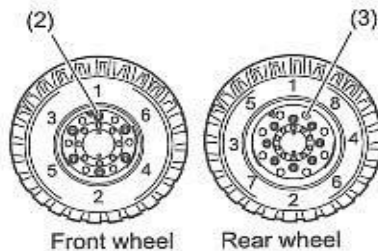
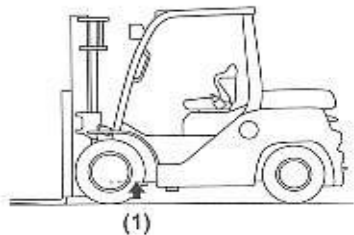

- (1) Front jack-up position
(2) Hub nuts
(3) Rim bolts

1. Ensure truck is on level ground and there is no load.
2. Apply the parking brake and chock the wheels. Locate the jack-up point at the bottom edge of the front plate of the frame. Securely insert the jack there. Confirm that the jack is properly positioned.
3. Jack up to just prior to the wheels coming up off the ground and loosen the hub nuts.

⚠ CAUTION

Always support the truck by blocking or jack stands after jacking up.

4. Jack up until the wheels come off the ground. Completely remove the air pressure from the tire then remove the hub nuts and remove the wheel.
5. To reinstall the wheel after changing a tire, perform the steps for removing in reverse order. The hub nuts should be tightened evenly and in the sequence shown in the figure.
6. After replacing the wheel, check and adjust the tire air pressure.

Rear wheels



1. Place the truck on level ground.
2. Apply the parking brake and chock the wheels then insert the jack under the counterweight.
3. Jack up to just prior to the wheels coming up off the ground and loosen the hub nuts.

⚠ CAUTION

Always support the truck by blocking or jack stands after jacking up.

⚠ CAUTION

Never loosen the divided rim nuts. Should any of the nuts be found loose or otherwise abnormal, deflate the tires and then loosen the hub nuts to remove the tires.

4. Jack up until the wheels come off the ground. Completely remove the air pressure from the tire then remove the hub nuts and remove the wheel.
5. To reinstall the wheel after changing a tire, perform the steps for removing in reverse order. The hub nuts should be tightened evenly and in the same sequence as for the front wheels.
6. After replacing the wheel, check and adjust the tire air pressure.

Jack setting position

- Hydraulic garage jack

Set the jack in the jack point under the counterweight.

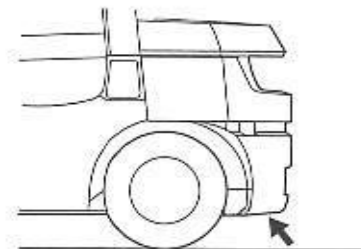



16.2 Using booster cables

If booster cables are available, it is possible to start the engine of a truck with a discharged battery using a fully charged booster battery in another truck.

Gasoline engine models (1 battery)

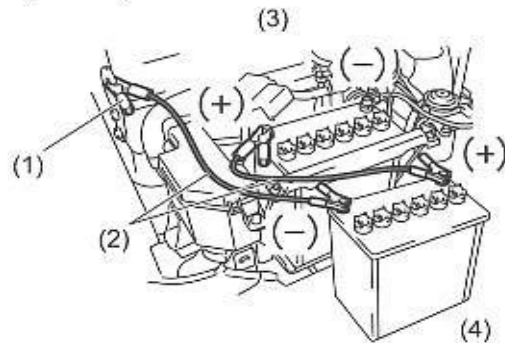

Diesel engine models (2 batteries)

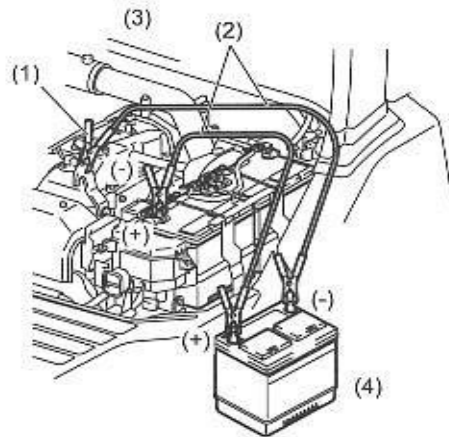

- (1) Engine hanger frame
- (2) Booster cables
- (3) Stalled truck
- (4) Helper truck

⚠ WARNING

To avoid damage to your truck, or the possibility of harm to yourself, follow these instructions and warnings. If you have any questions, ask the Toyota dealer.

- Never connect (+) to (-) or (-) to (+) as this may damage the alternator.
 - Do not connect batteries directly to avoid a danger of explosion. (An inflammable gas generated from batteries may catch fire.)
1. Use only a 12-volt battery for 12-volt battery models. If you are not sure of the voltage, or if the ground is different, do not try to boost start. Personal injury or damage to the electrical system can result. Damage to the electrical system will not be covered by the manufacturer's warranty.
 2. Check fluid level of the discharged battery. If low, add distilled water to the correct level. Be sure to install the caps before boost starting.

⚠ CAUTION

Use face shield to protect your face when adding water to the battery.

3. Put the booster battery as near to the truck as necessary for the booster cables to reach both batteries. Check and make sure that the trucks do not touch each other.
4. Use particular care when connecting a booster battery to prevent sparks. On both trucks, be sure to:
 - Apply the parking brake.
 - Put the control levers in the neutral position.
 - Turn off the key switch.
 - Turn all lights and accessories off and leave them off until after the engine has been started and the booster cables removed.
5. Connect the booster cables in the following procedure and sequence of the illustration:
 - Connect the red booster cable from the positive (+) terminal on the dead battery to the positive (+) terminal on the "helper truck" battery. Make sure the clamps do not touch any other metal.
 - Connect one end of the black cable to the ground (-) terminal of the helper truck battery.
 - Connect the other end of the black booster cable to the engine hanger frame of the stalled truck. (NOT TO NEGATIVE (-) TERMINAL OF THE BATTERY.)

NOTICE

Make this connection as far as possible from the battery. Do not connect it to pulleys, fans, or other parts that move.

6. Start the engine on the helper truck, and run the engine at a moderate speed.
7. Start the engine of the stalled truck. Be sure that the engine is at idle speed before disconnecting the booster cables.
8. Remove the booster cables by reversing the above sequence exactly. Start by removing the black booster cable from the engine hanger frame of the stalled truck. Then remove the other end of the negative (-) cable from the helper truck.
9. Remove both ends of the red cable.
10. After boost starting, be sure to fully charge the battery.



16 OPERATOR MAINTENANCE

16.3 Maintaining the battery terminals

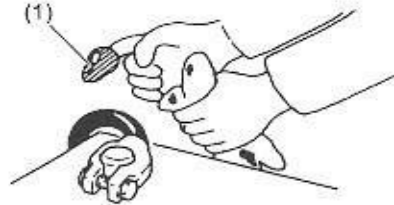

(1) Grease

1. A loose or corroded terminal causes failure in connection. Remove white powder, if any, from the terminal by pouring warm water over it to dissolve it and then apply grease on the terminal.
2. If the terminal is extremely corroded, remove it from the battery and brush off the corrosion using a wire brush or emery paper. Connect the terminal tightly to the battery and apply grease on the terminal.

⚠ WARNING

- Always stop the engine before working on the battery or terminals.
- Remove the negative terminal (-) first, but replace it last.
- Never allow an open flame near the battery. The battery produces explosive hydrogen gas. An open flame or spark can cause the gas to explode.
- Never allow the battery electrolyte to come into contact with the eyes, skin or clothing. The electrolyte used in battery contains diluted sulfuric acid, which causes burns and/or blindness. If battery electrolyte contacts your skin or clothing, flush the area immediately with cold water. If the electrolyte gets in the eyes, flush the eyes immediately with cold water and contact a doctor. Make sure that a shower and eye wash station are nearby.
- When cleaning the battery, make sure the vent caps are all tightly closed to prevent foreign materials from getting into.
- Always charge the battery in well-ventilated areas with all vent caps open. If the electrolyte temperature is increased over 45°C when charging, stop the charging operation and start it again when the electrolyte gets cold.
- Wash any electrolyte spilled with water.

16.4 Fuse Replacement

Fuse box

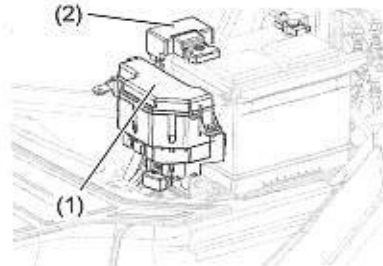

(1) Relay block
(2) Battery fusible link

If a lamp/light does not come on or an electrical device does not function, the corresponding fuse may have blown.

Check the fuse for each device. The fuse box is located next to the battery. Access the fuse box by opening the engine hood.

When replacing the battery fusible link or the middle fuses in the relay block, ask the Toyota dealer for the replacement.

See the fuse assignment table below for the device corresponding to each fuse.

Fuse assignment

A	30A	AM2	N	10A	WORKING LIGHT
B	20A	FRONT WIPER	M	15A	HEATER
C	20A	REAR WIPER	O	15A	HORN
D	20A	E-THRO (1FS Engine)	P	15A	HEAD LIGHT
		EDU (1KD Engine)	Q	7.5A	MATCH
E	20A	EFI (1FS Engine)	R	7.5A	START
F	20A	ACC-B	S	10A	GAUGE
G	10A	ACC-B2	T	10A	BACK LIGHT
H	7.5A	ALT-S	U	7.5A	SHIFT
I	7.5A	STOP	V	7.5A	TURN
J	7.5A	TAIL LIGHT	W	15A	IGNITION
K	7.5A	ECU-B	X	10A	ECU-IG
L	10A	EFI2	Y	10A	SAS-IG

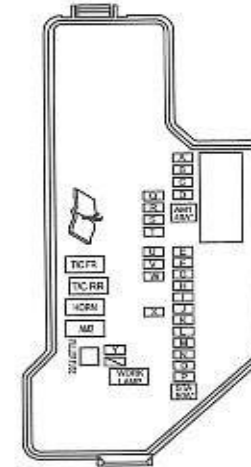

* : middle fuses

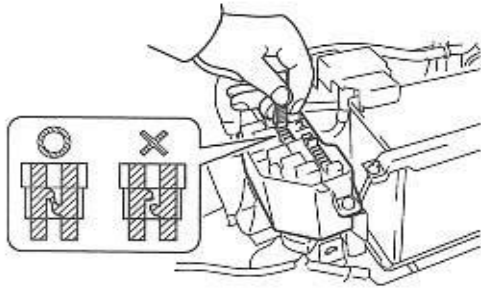

The fuse check and replacement procedure is as follows:

1. Turn off the key switch.
2. Remove the relay block cover and the fuse clip attached to the relay block.
3. Remove the fuse by clipping with fuse clip.
4. The fuse is blown if its state is as shown in the illustration. Replace it with a spare fuse.

⚠ CAUTION

Use a fuse having the capacity designated in the fuse assignment table.

⚠ CAUTION

If the replaced fuse blows again, ask the Toyota dealer for an inspection.

16.5 Air purging of the fuel system

(Diesel engine models)

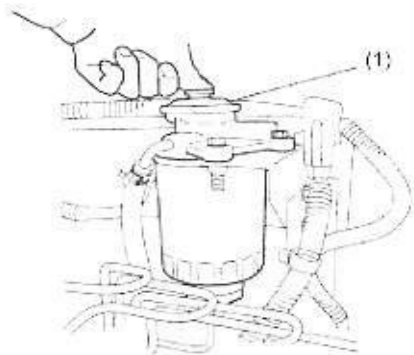

(1) Priming pump

When the fuel tank has been completely emptied or when maintenance has been performed on the fuel system, be sure to perform air purging in the following sequence.

1. Open the engine hood.
2. Operate the priming pump up and down to perform air bleeding.

⚠ CAUTION

Wipe up any fuel spill as it might cause a fire.

16.6 Draining the sedimenter

(Diesel engine models)

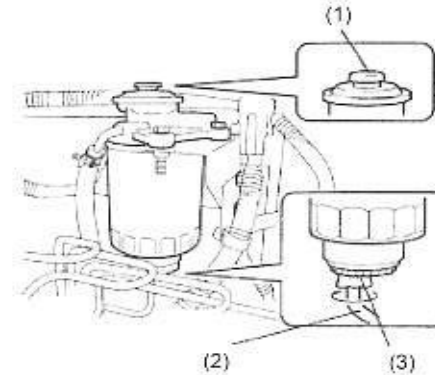

- (1) Priming pump
- (2) Drain hose
- (3) Drain plug

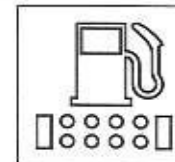

Sedimenter/ fuel filter warning

The sedimenter separates the water contained in the fuel. It is integrated with the fuel filter. If the sedimenter/fuel filter warning lamp comes on, immediately drain water according to the following procedure because the accumulated water in the sedimenter is above the specified level:

1. Place a container to receive the water under the open end of the drain hose under the fuel filter.
2. Turn the drain plug once or twice to loosen it and operate the priming pump up and down to drain the water from the sedimenter.

⚠ CAUTION

Be careful not to loosen the drain plug too much as fuel may spill from the plug.

3. When fuel starts to flow out after the water has drained, firmly tighten the drain plug.

⚠ CAUTION

Wipe up any fuel spill as it might cause a fire.

⚠ CAUTION

If the sedimenter/ fuel warning lamp continues to illuminate, after draining the water and while the engine is running, ask the Toyota dealer for an inspection.

16 OPERATOR MAINTENANCE

16.7 Adjusting of parking brake operating force

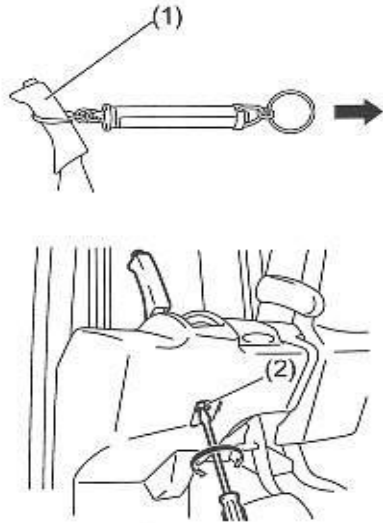

1. Attach a spring scale to the center of the grip of the parking brake lever.
2. Pull the scale backward to measure the operating force.

NOTICE

Please refer to **SERVICE DATA** section of this manual for the desired range of force value.

3. Should the force value be low or in excess of the desired range, adjust screw for higher and lower force and re-check.

Be sure to release the parking brake so brakes are not applied when the adjustment is made.

Turn clockwise - Higher (increase braking force)

Turn counterclockwise - Lower (decrease braking force)

- (1) Parking brake lever
(2) Screw

CAUTION

- If the force value is short of the desired range, it is very dangerous because the parking brake does not provide enough braking force. Be sure to adjust the force value to the desired range.
- Ask the Toyota dealer for an inspection if any abnormality is found.

16.8 Radiator fin cleaning

Clean the radiator and radiator fins. If debris is trapped in the fins, this may cause over-heating.

CAUTION

- After stopping the engine, confirm that the engine has sufficiently cooled down before you start cleaning. Take adequate precautions to avoid burns.
- When cleaning the radiator fins, take care not to cause it to become deformed.
- When cleaning, always wear safety goggles and dust mask.

16.9 Cleaning pre-cleaner (Option)

Pre-cleaner is mounted to the inlet port on the right side pillar of the overhead guard.

Inspect the pre-cleaner and clean it if the dust has accumulated up to the white line.



17 WEEKLY MAINTENANCE

To prevent malfunctions and accidents, it is important to perform weekly maintenance together with pre-operation checks. According to this section of the manual, inspect the trucks thoroughly to insure safety and pleasant working conditions. Have necessary adjustments or replacements performed by qualified service staff or by the Toyota dealer.

Lack of proper lubrication and servicing will quickly show up in increased breakdowns and shortening of the truck life.

Set up a certain day and make it a rule to inspect on that day. Record all inspection results and file them for future reference.

Perform the following inspection every week (40 hours of operation time) together with before-operation inspection.

Weekly (40 hours) Inspection Item	
Air cleaner	Clean
Fan and engine ancillary drive belt	Inspect
Battery electrolyte level	Check
Torque converter oil level	Check
Bolts and nuts	Tighten
Mast and steering linkage	Grease
Chain	Grease
Removing Tar from the LPG Regulator	Service

The above items are concerned with inspection and lubrication. Replacement of lubricants will depend on the amount of contamination and foreign matter in them. Changes should be made to conform with the conditions of your workplace and equipment.

17.1 Air cleaner cleaning

Element cleaning

⚠ CAUTION

Always use eye protection when cleaning with air.

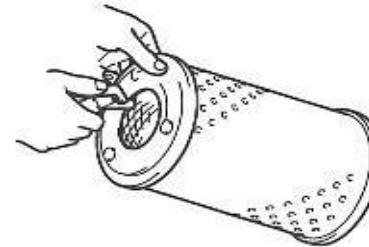
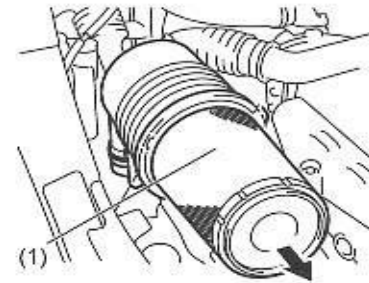

(1) Element

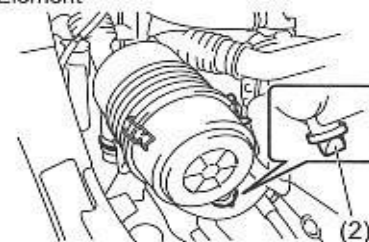

(2) Vacuator valve

1. Remove the three clips fixing the element and take out the element from the air cleaner.
2. Tap the element filter paper lightly without causing any damage or blow dust off with compressed air (700 kPa (7 kg/cm²) (99.4 psi) or less) from inside.
3. After the element is cleaned, remove any dust in the vacuator valve.

NOTICE

- Always replace the element if the filter paper is torn or damaged.
- Wash the element if heavily contaminated.

How to wash the element

1. Soak the element in water containing mild detergent for approximately 30 minutes and then wash. Use care not to scratch the filter paper.



17 WEEKLY MAINTENANCE

2. After washing, rinse the element with clean water (water pressure less than 280 kPa (2.8 kg/cm²) (40 psi)).
3. Allow to dry naturally or use a dryer (cold air). Never use compressed air or flame.

NOTICE

- The element should be replaced after washing six times or after it has been used for one year.
- It is unnecessary to clean the inside element when cleaning the double cyclone air cleaner (Option). Only clean the outside element. It is essential to replace both outside and inside elements, at time of replacement.

17.2 Fan and engine ancillary drive belt inspection

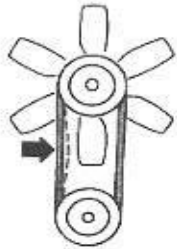

1FS (Gasoline) engine

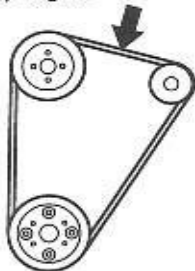

1KD (Diesel) engine

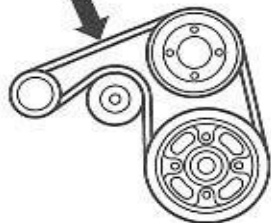

Inspect the fan and engine ancillary drive belt for cracks, fraying and tension. If any problem is found, have the belt replaced or adjusted by the Toyota dealer.

NOTICE

See the **SERVICE DATA** section of this manual for the proper tension.

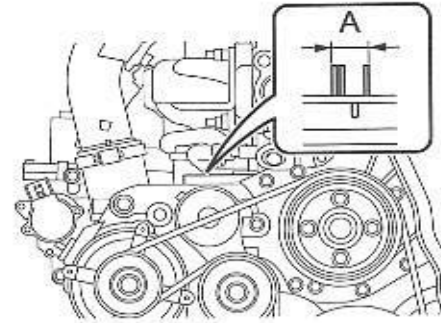

NOTICE

1KD engine ancillary drive belt is a ribbed type. The belt tension is automatically fixed by an auto tensioner. Inspect the ribbed V belt for cracks, fraying and the mark of tension adjustment condition. If the mark is outside of A as the drawing on the left indicates, the belt replacement is required.

17.3 Battery electrolyte check

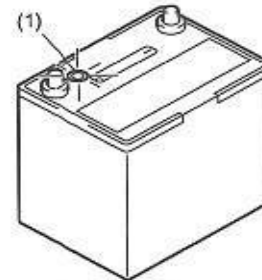

(1) Electrolyte level indicator

1. Use the electrolyte level indicator to check the battery condition.
2. The indicator shows green color if the electrolyte level is normal, white if the level is low, and red if the battery needs to be replaced.

⚠ WARNING

See **Battery Maintenance Section** of the separate publication, "Manual for Safe Operation", for important rules on batteries. Batteries can be very dangerous if you do not follow those rules.

NOTICE

When the indicator shows red color, ask the Toyota dealer to replace the battery.



17.4 Torque converter oil inspection

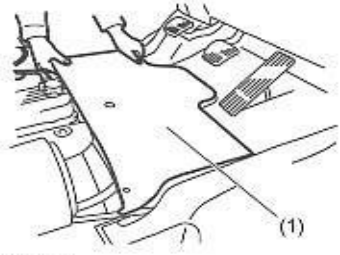

(1) Toe board

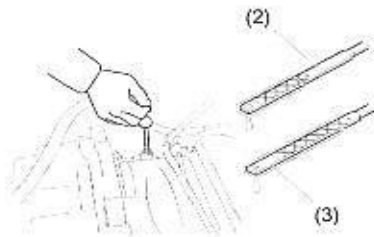

(2) COLD side

(3) HOT side

1. Park the truck on a safe and level ground with the direction control lever in the neutral position, stop the engine, apply the parking brake and the remove the key from the switch.

⚠ CAUTION

Inspect with the parking brake applied and the forks lowered to the ground.

2. Open the engine hood and remove the toe board.
3. Remove the level gauge and wipe it with clean cloth.
4. Insert the level gauge back into the transmission and extract it. Check that the oil level is between the F and L lines on the level gauge.

NOTICE

The level gauge contains the inscriptions "COLD" and "HOT" on either side. Conduct inspections using the "COLD" side before operating the truck and when the oil temperature is 40 °C or under. If you have operated the truck and the oil temperature is 60 °C or over, use the "HOT" side to conduct inspections after 30 seconds and within five minutes after the engine is stopped.

5. If the level is near or below the L line, add oil to the F line. Use only oil specified in the lubrication table.

17.5 Retightening of nuts and bolts

Retighten each nut and bolt on the chassis and load handling system.

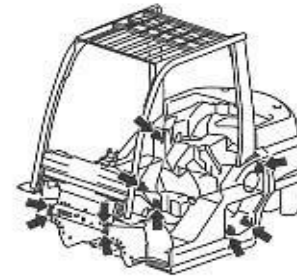

⚠ CAUTION

The frame is fixed by 10 frame bolts as shown in the figure to the left. Make sure not to loosen the frame bolts at the time of maintenance. In case the frame bolts are found loose, contact the Toyota dealer immediately for an inspection and repair. Never attempt to retighten the frame bolts by yourself. Do not use the truck until the frame bolts are retightened by the dealer.

17.6 Greasing chains, mast and steering linkage

Grease in accordance with the lubrication table.

⚠ CAUTION

- Clean the grease fittings thoroughly prior to greasing.
- After greasing, wipe off excess grease.

17 WEEKLY MAINTENANCE

17.7 Removing Tar from the Regulator (LPG and Gasoline-LPG models)

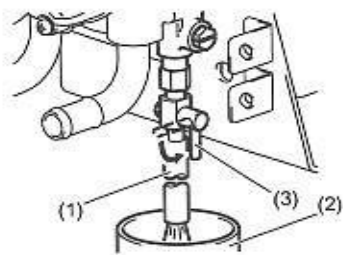

- (1) Hose
- (2) Oil pan
- (3) Drain cock (Option)

Tar tends to collect in the regulator and it must be removed regularly. Please refer to the periodic maintenance table. Tar removal should be completed as listed below after the engine has cooled down.

1. Set the fuel changeover switch to the OFF position (Gasoline- LPG models) and open the engine hood.
2. Put an oil pan under the regulator hose. Open the plug or the drain cock (Option) and let tar drop into the oil pan.
3. After all tar is removed from the regulator, close the plug completely, or turn the drain cock (Option) to the horizontal position.

⚠ CAUTION

Be sure to close the plug or the drain cock completely after removing tar, or it will cause LPG gas leakage.

⚠ CAUTION

If tar is adhering to the truck, it must be wiped off completely with a cloth.



18 FRAME SERIAL NUMBER

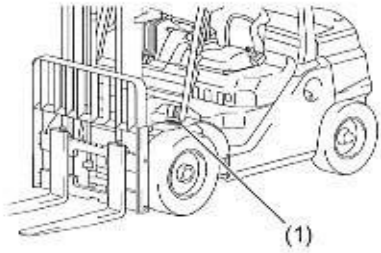

(1) Frame serial number

Frame serial number location

The frame serial number is stamped on the left mud guard. Refer to the frame serial number when making inquiries about your truck.



19 PROTECT YOUR INVESTMENT WITH TOYOTA GENUINE PARTS

19 PROTECT YOUR INVESTMENT WITH TOYOTA GENUINE PARTS

Why gamble with your valuable assets? When your forklift needs periodic maintenance - as every forklift does - you need Toyota Genuine Parts.

The same parts used on Toyota assembly lines - meeting the same tough Toyota standards for "PERFORMANCE", "DURABILITY", and "SAFETY".

TOYOTA GENUINE PARTS

Offer Excellent Dust-catching Performance on:

e.g. Air element, Torque converter oil filter, Return oil filter, Engine oil filter Fuel filter

TOYOTA GENUINE PARTS

Offer Supreme Durability on:

e.g. Clutch disc, Radiator hose, V belt

TOYOTA GENUINE PARTS

Ensure Safe Performance on:

e.g. Lift roller, Lift chain, Tie-rod end, Brake shoe

IF YOU USE A NON-GENUINE ENGINE OIL FILTER:

1. Clogging may result, which can lead to engine seizure.
2. The engine oil may become dirty faster, necessitating frequent oil changes.
3. It can pass dirty oil to the engine, causing engine wear.

IF YOU USE A NON-GENUINE RADIATOR HOSE:

1. The hose may wear out extremely rapidly.
2. The hose may be susceptible to water leakage, necessitating frequent replacement.

IF YOU USE A NON-GENUINE BRAKE SHOE:

1. Braking performance may be excessive, insufficient, or erratic, which is dangerous.
2. The brakes may drag, wasting fuel or battery power.

Call your Toyota authorized shop for after-sale service

With high quality TOYOTA genuine parts and superior service technology, Toyota helps keep customer's forklifts in the best condition for efficient work and higher productivity. We deliver satisfaction to the customers with Toyota genuine parts.





20 PERIODIC MAINTENANCE AND REPLACEMENT

Periodic inspection and maintenance are necessary to keep your Toyota industrial truck running safely and smoothly. The maintenance experts at the Toyota dealer are specially trained to use the right tools and approved procedures to protect the investment you have made in this high quality truck. Do not entrust it to amateurs.

The designated numbers of hours in the inspection cycle are as follow:

Daily (pre-operation check)- Every 8 hours

Weekly- Every 40 hours

Every 6 weeks- Every 250 hours

Every 3 months- Every 500 hours

Every 6 months- Every 1000 hours

Every 12 months- Every 2000 hours

If the operation time exceeds 250 hours within 6 weeks, use the number of hours as a guide for performing periodic inspection. Pre-operation checks and weekly inspections should preferably be performed by the user. 6-week, 3-month, 6-month and 12-month inspections should be performed by the Toyota dealer.

Refer to the Periodic Maintenance Table to determine the inspection and maintenance items and inspection cycles.

Use only genuine Toyota parts for replacements, and always use the recommended types of lubricants.

20.1 Periodic replacement of parts and lubricants

Replacement shall be made upon arrival of the operation hours or months, whichever is earlier.

•:Replacement

*:for new truck

Item	Inspection Period (Accumulated hours of operation or monthly periods of operation, whichever comes sooner.)			
	Every 6 weeks 250 hours	Every 3 months 500 hours	Every 6 months 1000 hours	Every 12 months 2000 hours
Engine oil	•*	•*2	•	•
Engine oil filter	•*	•*2	•	•
Engine coolant except LLC (every 2 years for LLC, every 3 years for Super LLC)		•	•	•
Fuel filter				•
Torque converter oil				•
Torque converter oil filter				•

Item	Inspection Period (Accumulated hours of operation or monthly periods of operation, whichever comes sooner.)			
	Every 6 weeks 250 hours	Every 3 months 500 hours	Every 6 months 1000 hours	Every 12 months 2000 hours
Differential gear oil				•
Planetary gear oil				•
Hydraulic oil				•
Hydraulic oil filter	•*			•
Wheel bearing grease				•
Spark plugs			•	•
Air cleaner element				•
Cups and seals for brake booster and wheel cylinders				•
Power steering hoses	Every 2 years			
Power steering rubbers parts	Every 2 years			
Hydraulic hoses	Every 2 years			
Fuel hoses	Every 2 years			
Torque converter rubber hoses	Every 2 years			
O-ring for LPG tank valve (Option)	Every 2 years			
LPG high and low-pressure rubber hoses (Option)	Every 2 years			
LPG regulator diaphragm and gas- ket, O-ring (Option)	Every 2 years			
LPG filter & shut-off valve diaphragm and gasket (Option)	Every 2 years			
Chains	Every 3 years			
Timing belt of 1KD *1	Every 4000 hours			
Hydraulic oil pump seal	Every 3 years or 6000 hours			
SAS Swing lock cylinder	Every 10000 hours			

*1: The timing belt caution function will inform the operator when the timing belt needs to be replaced. Refer to the INSTRUMENT chapter of this manual for details.

*2: Change the engine oil and oil filter at 6 months or 500 hours.

NOTICE

In case of the harsh or severe operating condition, the service interval of 170 hours or 1 month may be recommended.



20 PERIODIC MAINTENANCE AND REPLACEMENT

20.2 Periodic maintenance table

INSPECTION METHOD

I: Inspection. Repair or replacement if required.
 M: Measurement. Repair or adjustment if required.
 T: Retightening
 C: Cleaning
 L: Lubrication
 *: Same as the left column
 *1: For new truck
 *2: Fissure and crack detector

Inspection Period (Based on operating hours or months, whichever is soonest.)		Every 6 weeks	Every 3 months	Every 6 months	Every 12 months
Item		Every 250 hours	Every 500 hours	Every 1000 hours	Every 2000 hours
ENGINE					
Basic components	Proper starting and abnormal noise	I*1	I	*	*
	Rotating condition at idling	M*1	M	*	*
	Rotating condition during acceleration	M*1	M	*	*
	Exhaust gas condition	I*1	I	*	*
	Air cleaner element	C*1	C	*	*
	Valve clearance	M*1 (except 1KD en- gine)			M
	Muffler rubber mount				I
	Engine ancillary drive belt tension, looseness and damage	I*1	I	*	*
PCV system	Clogging and damage in PCV valve and piping	I*1	I	*	*
Lubrication system	Oil leak	I*1	I	*	*
	Oil level	I*1	I	*	*
	Clogging and dirt of oil filter		I	*	*
Fuel system	Fuel leak	I*1	I	*	*
	Dirt and clogging of fuel filter element		I	*	*
	Draining of sedimenter			I	*

Inspection Period (Based on operating hours or months, whichever is soonest.)		Every 6 weeks	Every 3 months	Every 6 months	Every 12 months
Item		Every 250 hours	Every 500 hours	Every 1000 hours	Every 2000 hours
Cooling system	Coolant level in radiator and leak	I*1	I	*	*
	Rubber hose degradation	I*1	I	*	*
	Radiator cap condition	I*1	I	*	*
	Fan belt tension, looseness and damage	I*1	I	*	*
	Radiator rubber mount				I
Exhaust emission control system (Option: 3-way Catalytic Converter)	Exhaust system piping joint loosening and damage				T
	Hose and piping damage	I*1	I	*	*
	Sensor damage				I
	Injection cleaning and damage of 1FS				I
	Resistor damage of 1FS				I
POWER TRANSMISSION SYSTEM					
Differential	Leak		I	*	*
	Oil level		I	*	*
	Bolt loosening				T
Planetary gear	Leak	I*1	I	*	*
	Oil level	I*1	I	*	*
	Bolt loosening				T
Torque converter & transmission	Leak		I	*	*
	Fluid level		I	*	*
	Operating mechanism function and looseness		I	*	*
	Control valve and clutch functions		I	*	*
	Inching valve function		I	*	*
	Stall and hydraulic pressure measurement			M	*
Propeller shaft and axle shaft	Loose joint		I	*	*
	Looseness at spline connections				I
	Looseness of universal joint				I
	Twisting and cracks of axle shaft				I



Inspection Period (Based on operating hours or months, whichever is soonest.)		Every 6 weeks	Every 3 months	Every 6 months	Every 12 months
Item		Every 250 hours	Every 500 hours	Every 1000 hours	Every 2000 hours
DRIVE SYSTEM					
Wheels	Tire inflation pressure		M	*	*
	Tire cuts, damage and uneven wear- ing		I	*	*
	Loose rim and hub nuts		T	*	*
	Tire groove depth	M*1	M	*	*
	Metal chips, pebbles and other for- eign matter trapped in tire grooves	I*1	I	*	*
	Rim, side bearing and disc wheel damage	I*1	I	*	*
	Abnormal sound and looseness of front wheel bearing	I*1	I	*	*
	Abnormal sound and looseness of rear wheel bearing	I*1	I	*	*
Front axle	Cracks, damage and deformation of housing				I
Rear axle	Cracks, damage and deformation of beam				I
	Looseness of axle beam in vehicle longitudinal direction				M
STEERING SYSTEM					
Steering wheel	Play and looseness	I*1	I	*	*
	Function	I*1	I	*	*
Steering valve	Oil leak	I*1	I	*	*
	Looseness of mounting	T*1	T	*	*
Power Steering	Oil leak		I	*	*
	Mounting and linkage looseness		I	*	*
	Damage of power steering hose				I
Knuckle	King pin looseness		I	*	*
	Cracks and deformation				I
BRAKING SYSTEM					
Brake pedal	Play and reserve		M	*	*
	Braking effect		I	*	*

Inspection Period (Based on operating hours or months, whichever is soonest.)		Every 6 weeks	Every 3 months	Every 6 months	Every 12 months
Item		Every 250 hours	Every 500 hours	Every 1000 hours	Every 2000 hours
Parking brake	Operating force		I	*	*
	Braking effect		I	*	*
	Rod and cable looseness and dam- age	I*1	I	*	*
Brake pipe	Leak, damage and mounting condi- tion		I	*	*
Brake booster and wheel cylin- der	Function, wear, damage, leak and mounting looseness				I
Brake drum and brake shoe	Clearance between drum and lining		M	*	*
	Wear of shoe sliding portion and lin- ing				I
	Drum wear and damage				I
	Shoe operating condition				I
	Anchor pin rusting				I
	Return spring fatigue				M
Backing plate	Automatic adjuster function				I
	Deformation, cracks and damage				I
	Loose mounting				T
LOAD HANDLING SYSTEM					
Forks	Abnormality of fork and stopper pin		I	*	*
	Misalignment between left and right fork fingers		I	*	*
	Cracks at fork heel and hangers				I*2
Mast and lift bracket	Deformation and damage of each part and cracks on welded parts		I	*	*
	Mast and lift bracket looseness		I	*	*
	Wear and damage of mast support bushing				I
	Wear, damage and rotating condition of rollers		I	*	*
	Wear and damage of roller pins				I
	Wear and damage of mast channel		I	*	*



20 PERIODIC MAINTENANCE AND REPLACEMENT

Inspection Period (Based on operating hours or months, whichever is soonest.)		Every 6 weeks	Every 3 months	Every 6 months	Every 12 months
Item		Every 250 hours	Every 500 hours	Every 1000 hours	Every 2000 hours
Chain and chain wheel	Tension, deformation and damage of chains	I*	I	*	*
	Chain lubrication		I	*	*
	Elongation of chains				I
	Abnormality of chain anchor bolts		I	*	*
	Wear, damage and rotating condition of chain pulleys		I	*	*
Various attachments	Abnormality and mounting condition of each part		I	*	*
HYDRAULIC SYSTEM					
Cylinder	Loosening and damage of cylinder mounting		T	*	*
	Deformation and damage of rod, rod screw and rod end		I	*	*
	Cylinder operation		I	*	*
	Natural drop and natural forward tilt (hydraulic drift)		M	*	*
	Oil leak and damage		I	*	*
	Wear and damage of pin and cylinder support		I	*	*
	Lifting speed		M	*	*
	Uneven movement		I	*	*
Oil pump	Oil leak and abnormal sound		I	*	*
Hydraulic oil tank	Oil level and contamination		I	*	*
	Tank and oil strainer			C	*
	Oil leak		I	*	*
Control lever	Loose linkage		I	*	*
	Operation		I	*	*
Oil control valve	Oil leak		I	*	*
	Relief pressure measurement				M
	Relief valve and tilt lock valve functions		I	*	*

Inspection Period (Based on operating hours or months, whichever is soonest.)		Every 6 weeks	Every 3 months	Every 6 months	Every 12 months	
Item		Every 250 hours	Every 500 hours	Every 1000 hours	Every 2000 hours	
Hydraulic piping	Oil leak		I	*	*	
	Deformation and damage		I	*	*	
	Loose joint		T	*	*	
ELECTRICAL SYSTEM						
Ignition system	State of spark plug (carbon, soot)	I*	I	*	*	
Starter motor	Pinion gear meshing status		I	*	*	
Battery	Battery electrolyte level		I	*	*	
	Battery electrolyte specific gravity			M	*	
Electrical wiring	Damage of wiring harness		I	*	*	
	Fuses		I	*	*	
Preheater	Open-circuit in glow plug			I	*	
LPG DEVICE						
LPG Device (Option)	Gas leak from fuel lines and fittings	I*	I	*	*	
	Damage of fuel lines and fittings	I*	I	*	*	
	Tar removal from regulator	C*	C	*	*	
	Regulator adjustment status	I*	I	*	*	
	Regulator function		I	*	*	
	Mixer		I	*	*	
	Filter clogging		C	*	*	
	Service valve function		I	*	*	
	Leaks, damage, and cracks of the tank	I*	I	*	*	
	Loose or damaged tank bracket	I*	I	*	*	
	Damage to electrical wiring, loose terminals	I*	I	*	*	
	Rotation of liquid drain valve	I*	I	*	*	
	Gas leak from the regulator body	I*	I	*	*	
	SAFETY DEVICES AND OTHERS					
	Overhead guard	Cracks at welded portion		I	*	*
Deformation and damage			I	*	*	
Back-rest	Loosening of mounting		T	*	*	
	Deformation, crack and damage		I	*	*	



Inspection Period (Based on operating hours or months, whichever is soonest.)		Every 6 weeks	Every 3 months	Every 6 months	Every 12 months
Item		Every 250 hours	Every 500 hours	Every 1000 hours	Every 2000 hours
Lighting system	Function and mounting condition		I	*	*
Horn	Function and mounting condition		I	*	*
	Grease horn contact ring and horn contact spring				L
Instruments	Functions		I	*	*
Backup buzzer (Option)	Function and mounting condition		I	*	*
Rear-view mirror (Option)	Dirt, damage		I	*	*
	Rear reflection status		I	*	*
Seat	Loosening and damage of mounting		I	*	*
	Seat damage and function		I	*	*
Seat belt	Mounting looseness		I	*	*
	Webbing damage (cut, frayed straps, loose stitching)		I	*	*
	Tongue damage		I	*	*
	Buckle and retractor damage		I	*	*
	Function (retract and locks)		I	*	*
Body	Damage and cracks of frame, cross members, etc.				I
	Bolt looseness				T
	Frame bolt				I
SAS	Functions		I	*	*
	Loosening and damage at sensor mounting		I	*	*
	Damage, deformation, oil leakage and loosening of the mounting of functional parts		I	*	*
	Loosening and damage of wire harnesses		I	*	*
	Lock cylinder accumulator performance				I
	Rusting and corrosion of load sensor				I
OPS	Functions	I*1	I	*	*

Inspection Period (Based on operating hours or months, whichever is soonest.)		Every 6 weeks	Every 3 months	Every 6 months	Every 12 months
Item		Every 250 hours	Every 500 hours	Every 1000 hours	Every 2000 hours
Others	Grease (See the LUBRICATION CHART of this manual)		L	*	*

NOTICE

In case of the harsh or severe operating condition, the service interval of 170 hours or 1 month may be recommended.



21 SERVICE DATA

21 SERVICE DATA

Adjustment valve table

ENGINE

Engine model		1FS (Gasoline)	1KD (Diesel)
Item			
Fan belt tension [3 kg (7 lb) pressure applied]	mm (in)	New: 3.2 - 4.0 (0.13 - 0.16) Inspection: 4.7 - 5.5 (0.19 - 0.22)	←
V belt tension [10 kg (22 lb) pressure applied]	mm (in)	New: 7 - 9 (0.28 - 0.35) Inspection: 8 - 13 (0.31 - 0.51)	(Only tension condition check)
Spark plug gap	mm (in)	0.7 - 0.8 (0.0315)	-
Spark plug type		K16HR-UA8	-
Ignition or fuel injection sequence		1-3-4-2	1-3-4-2
Valve clearance(Cold engine)	Intake	0.16 (0.006)	0.25 - 0.30 (0.010 - 0.012)
	Exhaust	0.3 (0.012)	0.35 - 0.45 (0.014 - 0.018)
Engine compression	Standard valve	1550/250 (15.8/250) {224.8/250}	2500/250 (25.5/250) {362/250}
	Limit	1100/250 (11.2/250) {159.5/250}	2000/250 (20.4/250) {290/250}
Idling speed	rpm	750±30	750±30
No load maximum speed	3.5 - 5.0 ton	2350±35	2350±35
	6.0 - 8.0 ton	2550±35	2600±35

BATTERY

Battery electrolyte specific gravity [at 20°C (68°F)]	1.280
---	-------

STEERING

Steering wheel play (at engine idle speed)	25 - 50 (1.0 - 2.0)
mm (in)	

BRAKE

Brake pedal	mm (in)	Play	3 - 7 (0.12 - 0.28)
		Floor clearance (pedal pressure: approx. 196 N [20kgf])	95 (3.74) or more
Inching pedal		Pedal depression	27 - 33 (1.06 - 1.30)
Brake and inching pedal (Option: Single brake pedal)	mm (in)	Floor clearance (pedal pressure: approx. 196 N [20kgf])	60 (2.36) or more
		Pedal depression	26 - 32 (1.02 - 1.26)
Parking brake operating force	N (lb)	3.5 - 4.5 ton	226 - 265 (50.8 - 59.5)
		6.0 - 7.0 ton	
		5.0 ton, 8.0 ton	275 - 315 (61.8 - 70.8)

OIL CONTROL VALVE

Model		3.5 - 5.0 ton	6.0 - 8.0 ton
Item			
Set pressure	Lift	18100 (185) [2630]	20600 (210) [2990]
	Tilt		
kPa (kg/cm ²) [psi]			

WHEEL

Front tire air pressure

Series	Type	Tire size	Rim	Air pressure kPa(psi)
3.5 - 4.0 ton	Standard	250-15-20PR	Side ring	825 (120)
	Standard Dual	28 x 8-15-12PR	Side ring	700 (102)
4.5 - 5.0 ton	Standard	300-15-20PR	Side ring	800 (116)
	Special Dual	8.25-15-14PR	Side ring	800 (116)
6.0 - 8.0 ton	Standard Dual	8.25-15-14PR	Side ring	800 (116)



Rear tire air pressure

Series	Type	Tire size	Rim	Air pressure kPa(PSI)
3.5 ton	Standard	7.00-12-14PR	Divided	850 (123)
	Side Ring	7.00-12-14PR	Side ring	900 (131)
4.0 - 4.5 ton	Standard	7.00-12-14PR	Divided	850 (123)
	Side Ring	7.00-12-14PR	Side ring	900 (131)
5.0 ton	Standard	7.00-12-14PR	Side ring	900 (131)
6.0 - 8.0 ton	Standard	8.25-15-14PR	Side ring	800 (116)

Hub nut tightening torque

	Series	Hub nut tightening torque N-m(kgf-m)[ft-lbs]
Front		294 - 588 (30.0 - 60.0) [217 - 434]
Rear	3.5 - 5.0 ton	177 - 392 (18.0 - 40.0) [131 - 289]
	6.0 - 8.0 ton	294 - 588 (30.0 - 60.0) [217 - 434]

SOUND PRESSURE LEVEL

		1FS (Gasoline)		1KD (Diesel)	
		3.5 - 5.0 ton	6.0 - 8.0 ton	3.5 - 5.0 ton	6.0 - 8.0 ton
Sound pressure level (L_{pA}) in accordance with EN 12053 Uncertainty $K=4$ dB (A) dB (A)	Standard	80	80	77	79
	Cabin Models	80	80	78	80

VIBRATION

Engine	Standard	Low height overhead guard models (Option) *1
Vibration in accordance with EN 13059 m/s ²	1.0	2.0

*1: Since suspension-less operator's seat is equipped, the vibration level increases comparing with standard trucks.

NOTICE

- The sound pressure values shown in the table can be used as the sound level at operators' ears. (Values are in accordance with EN 12053 measurement methods.)
- When the truck is equipped with options, such as plate fin radiator, upswept muffler, front glass, high speed fan or high capacity cooling, the noise level at operator's ear increases as compared with a standard truck (from 1 to 3 dB (A)).
- The vibration values shown above are obtained from the measurements in accordance with EN 13059.
- The magnitude of hand arm vibration of lift trucks is 2.5 m/s² or below as defined in EN 13059.
- The whole body vibration values shown above cannot be used for calculating 8 hour vibration exposure in 2002/44/EC (Vibration Directive). (If calculated according to the general forklift operation pattern, the result will be lower than 0.5 m/s².)



22 RECOMMENDED LUBRICANT QUANTITY & TYPES

22 RECOMMENDED LUBRICANT QUANTITY & TYPES

Description		Application	Quantity ℓ (US gal)	Classification	Type
Engine oil	Gasoline	1FS	All: 8.8 (2.32) Oil pan: 8.2 (2.17)	API SN or better	SAE 10W-30
	Diesel	1KD	All: 7.8 (2.06) Oil pan: 6.6 (1.74)	API CF-4 or better	<ul style="list-style-type: none"> • SAE 10W-30 • 5W-30 (in cold areas)
Torque converter oil		1FS, 1KD	15.5 (4.09)	ATF	GM Dexron® II
Differential gear oil		3.5 - 5.0 ton	9.5 (2.51)	API GL-4 API GL-5	Hypoid gear oil SAE 85W-90
		6.0 - 8.0 ton	10.5 (2.77)		
Planetary gear oil		6.0 - 8.0 ton	0.8 (0.21)	ISO VG32	Hydraulic oil
Hydraulic oil (V mast, max. lifting height 5000mm (197in))		3.5 - 4.0 ton	57.5 (15.2)		
		4.5 - 5.0 ton	64.5 (17.0)		
Fuel tank		6.0 - 8.0 ton	73.5 (19.4)	-	Refer to Fuel level check and supply (Gasoline and diesel models) for the recommended type of fuel.
		3.5 - 4.0 ton	90 (23.8)		
		4.5 - 5.0 ton	120 (31.7)		
Chassis parts		6.0 - 8.0 ton	130 (34.3)	-	<ul style="list-style-type: none"> • MP grease • Molybdenum disulfide grease
		All models	Proper quantity		
		Engine cooling system (excluding reservoir tank)			
Diesel	1KD			9.5 (2.5)	
Radiator reservoir tank (at FULL mark level)		All models	Proper quantity		

NOTICE

The LLC has changed to Toyota Super LLC (used also for Toyota Cars). In connection we have the following requirement:

- Do not use only water.
- Use of improper engine coolant may damage the engine coolant system.
- Use only Toyota Super LLC or similar high quality specifications:
 - ethylene glycol based non-silicate
 - non-amine
 - non-nitrite
 - non-borate engine coolant with long-life hybrid organic acid technology.
- Note that coolant with long-life hybrid organic acid technology consists of a combination of low phosphates and organic acids.



23 LUBRICATION CHART

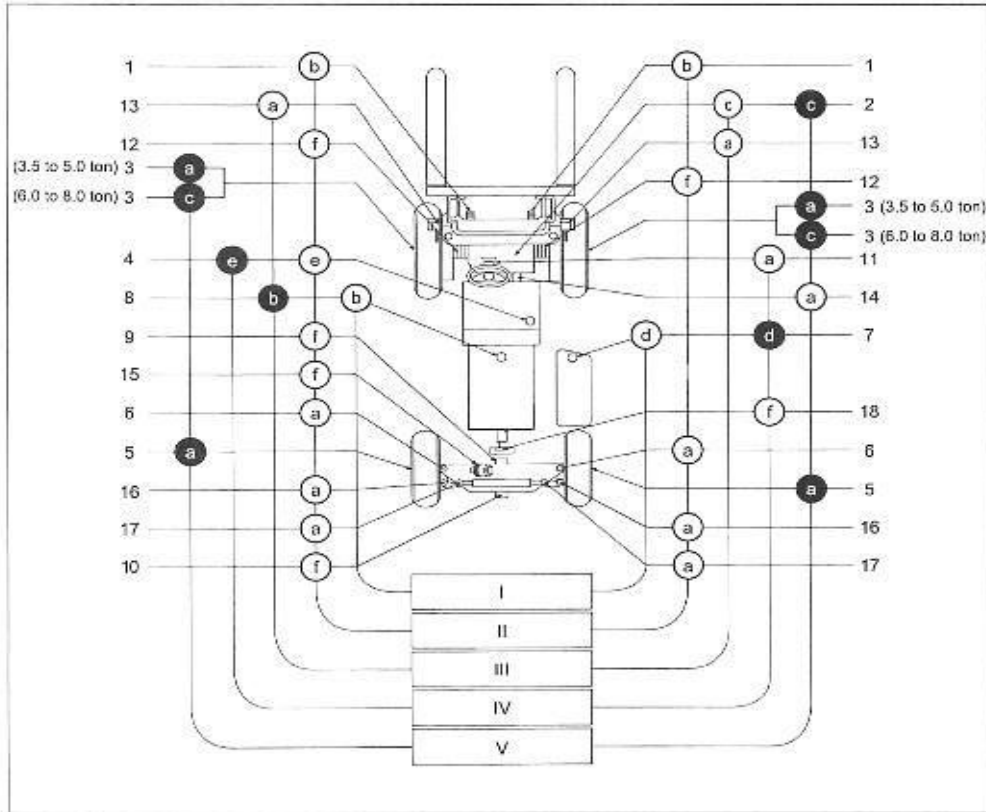

Inspection or replacement oil

○	Inspection
●	Replacement
a	MP grease
b	Engine oil
c	Hypoid gear oil
d	Hydraulic oil
e	Automatic transmission fluid
f	Molybdenum disulfide grease

Inspection cycle

I	Inspect every 8 hours (daily)
II	Inspect every 40 hours (weekly)
III	Inspect every 500 hours (3 monthly)
IV	Inspect every 1000 hours (6 monthly)
V	Inspect every 2000 hours (annual)

Inspection parts

1	Chain
2	Differential gear
3	Front wheel bearing (3.5 to 5.0 ton) Planetary gear (6.0 to 8.0 ton)
4	Torque converter case
5	Rear wheel bearing
6	Steering knuckle king pin
7	Oil tank
8	Engine crank case
9	Rear axle beam front pin
10	Rear axle beam rear pin
11	Tilt steering locking mechanism
12	Mast support bushing
13	Tilt cylinder front pin
14	Propeller shaft
15	Swing lock cylinder lower pin
16	Tie rod end pin
17	Rear axle cylinder end pin
18	Fan drive shaft



24 TRUCK DIMENSIONS

24 TRUCK DIMENSIONS

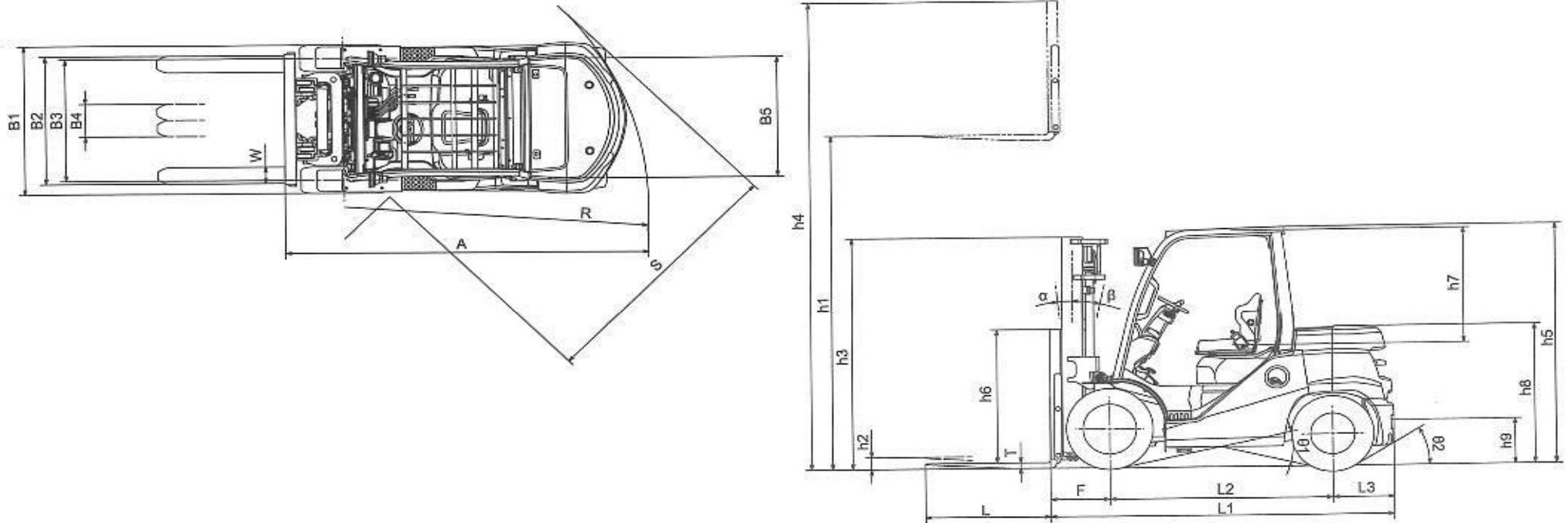

mm (in)

	8FG35N	40-8FD35N	8FG40N	40-8FD40N	8FG45N	40-8FD45N	8FG50N	40-8FD50N	8FG60N	40-8FD60N	8FG70N	40-8FD70N	8FG80N	40-8FD80N
A *1	3120 (122.5)	3120 (122.5)	3170 (124.5)	3170 (124.5)	3300 (129.5)	3300 (129.5)	3370 (132.5)	3370 (132.5)	3810 (150)	3810 (150)	3870 (152)	3870 (152)	3910 (154)	3910 (154)
B1	1350 (53.1)	1350 (53.1)	1350 (53.1)	1350 (53.1)	1450 (57.1)	1450 (57.1)	1450 (57.1)	1450 (57.1)	1965 (77.4)	1965 (77.4)	1965 (77.4)	1965 (77.4)	1965 (77.4)	1965 (77.4)
B2/B4	1170/300 (46.1/11.8)	1170/300 (46.1/11.8)	1170/300 (46.1/11.8)	1170/300 (46.1/11.8)	1160/300 (45.7/11.8)	1160/300 (45.7/11.8)	1160/300 (45.7/11.8)	1160/300 (45.7/11.8)	1700/300 (66.9/11.8)	1700/300 (66.9/11.8)	1700/300 (66.9/11.8)	1700/300 (66.9/11.8)	1700/300 (66.9/11.8)	1700/300 (66.9/11.8)
B3	1115 (43.9)	1115 (43.9)	1115 (43.9)	1115 (43.9)	1115 (43.9)	1115 (43.9)	1115 (43.9)	1115 (43.9)	1440 (56.7)	1440 (56.7)	1440 (56.7)	1440 (56.7)	1440 (56.7)	1440 (56.7)
B5	1100 (43.3)	1100 (43.3)	1100 (43.3)	1100 (43.3)	1100 (43.3)	1100 (43.3)	1100 (43.3)	1100 (43.3)	1460 (57.5)	1460 (57.5)	1460 (57.5)	1460 (57.5)	1460 (57.5)	1460 (57.5)
F	505 (19.9)	505 (19.9)	505 (19.9)	505 (19.9)	545 (21.5)	545 (21.5)	555 (21.9)	555 (21.9)	580 (22.8)	580 (22.8)	585 (23.0)	585 (23.0)	590 (23.2)	590 (23.2)



	8FG35N	40-8FD35N	8FG40N	40-8FD40N	8FG45N	40-8FD45N	8FG50N	40-8FD50N	8FG60N	40-8FD60N	8FG70N	40-8FD70N	8FG80N	40-8FD80N
h1	3000 (118)	3000 (118)	3000 (118)	3000 (118)	3000 (118)	3000 (118)	3000 (118)	3000 (118)	3000 (118)	3000 (118)	3000 (118)	3000 (118)	3000 (118)	3000 (118)
h2	110 (4.3)	110 (4.3)	110 (4.3)	110 (4.3)	110 (4.3)	110 (4.3)	120 (4.7)	120 (4.7)	125 (4.9)	125 (4.9)	125 (4.9)	125 (4.9)	130 (5.1)	130 (5.1)
h3	2110 (83)	2110 (83)	2110 (83)	2110 (83)	2200 (86.5)	2200 (86.5)	2450 (96.5)	2450 (96.5)	2460 (96.8)	2460 (96.8)	2460 (96.8)	2460 (96.8)	2610 (102.8)	2610 (102.8)
h4	4270 (168.1)	4270 (168.1)	4270 (168.1)	4270 (168.1)	4270 (168.1)	4270 (168.1)	4435 (174.6)	4435 (174.6)	4435 (174.6)	4435 (174.6)	4435 (174.6)	4435 (174.6)	4440 (174.8)	4440 (174.8)
h5	2210 (87.0)	2210 (87.0)	2210 (87.0)	2210 (87.0)	2300 (90.5)	2300 (90.5)	2300 (90.5)	2300 (90.5)	2310 (90.9)	2310 (90.9)	2310 (90.9)	2310 (90.9)	2310 (90.9)	2310 (90.9)
h6	1220 (48.0)	1220 (48.0)	1220 (48.0)	1220 (48.0)	1220 (48.0)	1220 (48.0)	1370 (54.0)	1370 (54.0)	1370 (54.0)	1370 (54.0)	1370 (54.0)	1370 (54.0)	1370 (54.0)	1370 (54.0)
h7	1030 (40.6)	1030 (40.6)	1030 (40.6)	1030 (40.6)	1030 (40.6)	1030 (40.6)	1030 (40.6)	1030 (40.6)	1030 (40.6)	1030 (40.6)	1030 (40.6)	1030 (40.6)	1030 (40.6)	1030 (40.6)
h8	1300 (51.2)	1300 (51.2)	1300 (51.2)	1300 (51.2)	1330 (52.4)	1330 (52.4)	1325 (52.2)	1325 (52.2)	1350 (53.1)	1350 (53.1)	1350 (53.1)	1350 (53.1)	1350 (53.1)	1350 (53.1)
h9	420 (16.5)	420 (16.5)	420 (16.5)	420 (16.5)	420 (16.5)	420 (16.5)	420 (16.5)	420 (16.5)	485 (19.1)	485 (19.1)	485 (19.1)	485 (19.1)	485 (19.1)	485 (19.1)
L	1000 (39)	1000 (39)	1000 (39)	1000 (39)	1000 (39)	1000 (39)	1200 (47)	1200 (47)	1200 (47)	1200 (47)	1200 (47)	1200 (47)	1200 (47)	1200 (47)
L1	2925 (115.2)	2925 (115.2)	2980 (117.3)	2980 (117.3)	3110 (122.4)	3110 (122.4)	3170 (124.8)	3170 (124.8)	3490 (137.4)	3490 (137.4)	3545 (139.6)	3545 (139.6)	3590 (141.3)	3590 (141.3)
L2	1900 (74.8)	1900 (74.8)	1900 (74.8)	1900 (74.8)	2000 (78.7)	2000 (78.7)	2000 (78.7)	2000 (78.7)	2250 (88.6)	2250 (88.6)	2250 (88.6)	2250 (88.6)	2250 (88.6)	2250 (88.6)
L3	520 (20.5)	520 (20.5)	575 (22.6)	575 (22.6)	565 (22.2)	565 (22.2)	615 (24.2)	615 (24.2)	660 (26.0)	660 (26.0)	710 (28.0)	710 (28.0)	750 (29.5)	750 (29.5)
R	2610 (103)	2610 (103)	2660 (104.5)	2660 (104.5)	2750 (108.5)	2750 (108.5)	2810 (110.5)	2810 (110.5)	3230 (127)	3230 (127)	3280 (129)	3280 (129)	3320 (131)	3320 (131)
S	2260 (89.0)	2260 (89.0)	2280 (90.0)	2280 (90.0)	2380 (93.5)	2380 (93.5)	2430 (95.5)	2430 (95.5)	2880 (113.5)	2880 (113.5)	2910 (114.5)	2910 (114.5)	2930 (115.5)	2930 (115.5)
T	50(2.0)	50(2.0)	50(2.0)	50(2.0)	50(2.0)	50(2.0)	60(2.4)	60(2.4)	60(2.4)	60(2.4)	65(2.6)	65(2.6)	70(2.8)	70(2.8)
W	150(6.0)	150(6.0)	150(6.0)	150(6.0)	150(6.0)	150(6.0)	150(6.0)	150(6.0)	150(6.0)	150(6.0)	150(6.0)	150(6.0)	150(6.0)	150(6.0)
α/β (deg)	6/12	6/12	6/12	6/12	6/12	6/12	6/12	6/12	6/12	6/12	6/12	6/12	6/12	6/12
θ1 (%)	50	42	50	42	56	50	55	50	48	45	48	45	47	44
θ2 (%)	61	61	55	55	66	66	56	56	69	69	60	60	54	54

*1: Add load length and clearance for basic right angle stacking aisle width. Ask the Toyota dealer for the detailed calculation.



24 TRUCK DIMENSIONS

24.1 Truck weight

kg

	8FG35N	40-8FD35N	8FG40N	40-8FD40N	8FG45N	40-8FD45N	8FG50N	40-8FD50N	8FG60N	40-8FD60N	8FG70N	40-8FD70N	8FG80N	40-8FD80N
Truck total weight	5700	5780	6070	6150	6610	6690	7140	7220	8370	8360	9030	9090	9880	9940
Front axle load (with load)	8670	8690	9360	9380	10430	10450	10880	10910	12900	12850	14300	14330	15830	15860
Front axle load (without load)	2550	2570	2480	2500	2830	2850	3000	3030	3750	3705	3610	3640	3600	3630
Rear axle load (with load)	1030	1090	1210	1270	1170	1230	1260	1310	1470	1510	1730	1760	2050	2080
Rear axle load (without load)	3150	3210	3590	3650	3780	3840	4140	4190	4620	4655	5420	5450	6280	6310